

# SOLEIL NOIR

design Odile Decq

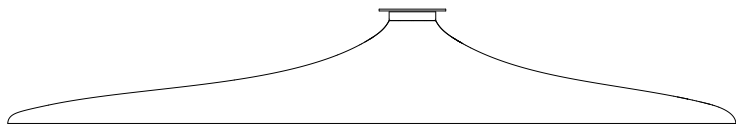

**LUCE  
PLAN**

---

D89p



## D89p

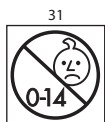
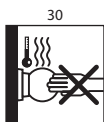
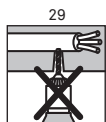
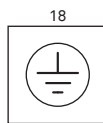
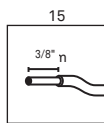
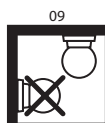
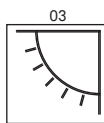
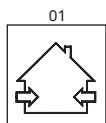

---

D89p

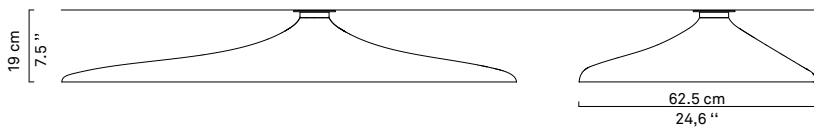
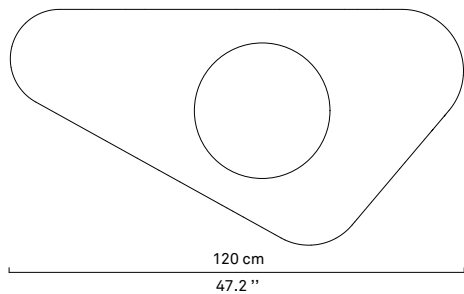

---

**kg** 6.1 kg    **lb** 13.5 lb

## D89p



a



b

x1

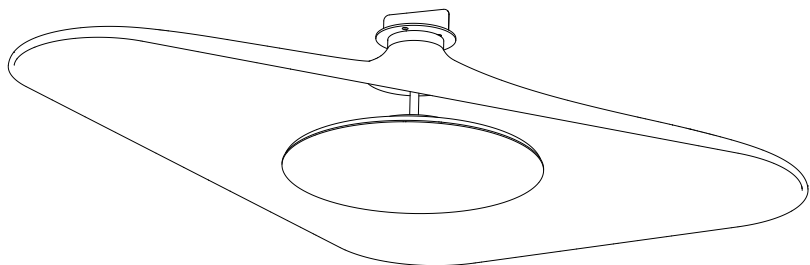

D89p

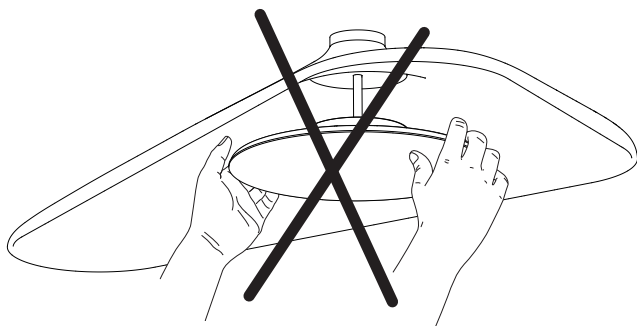
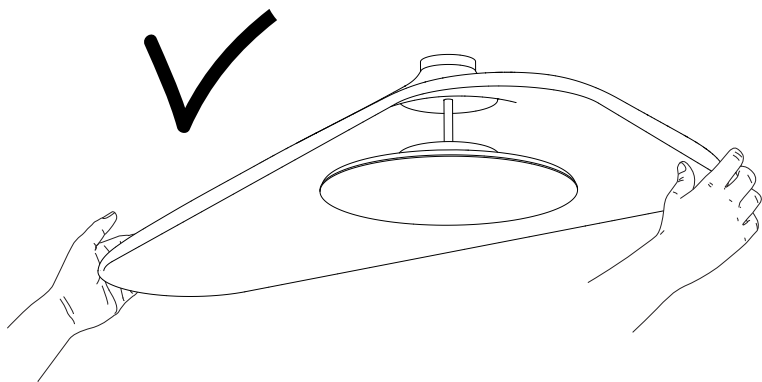

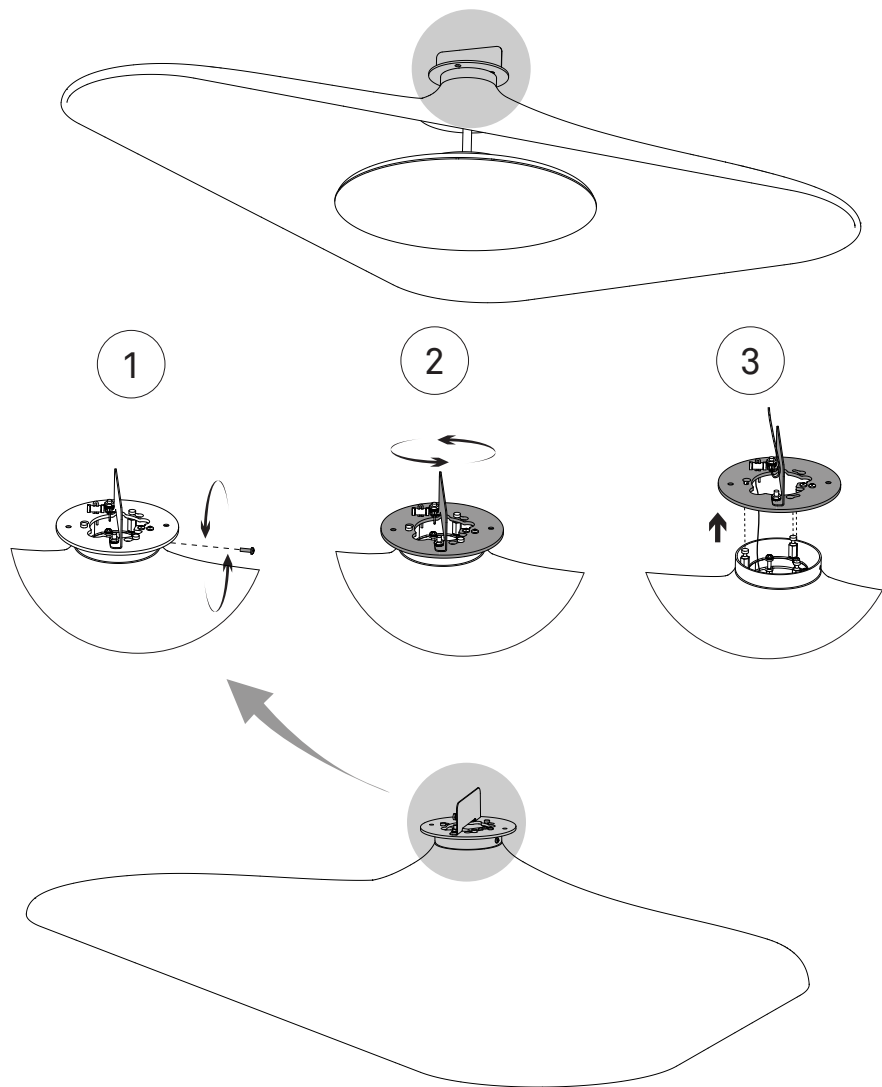

D89p

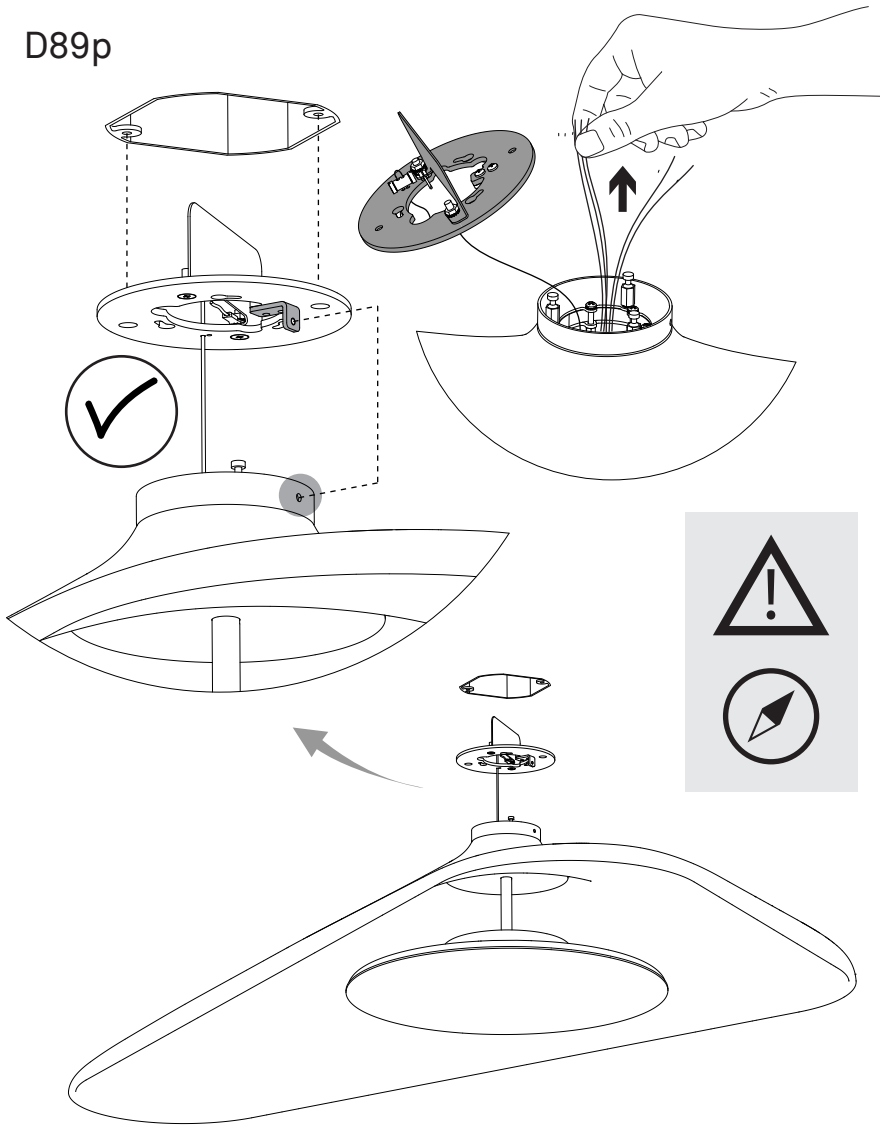

## D89p

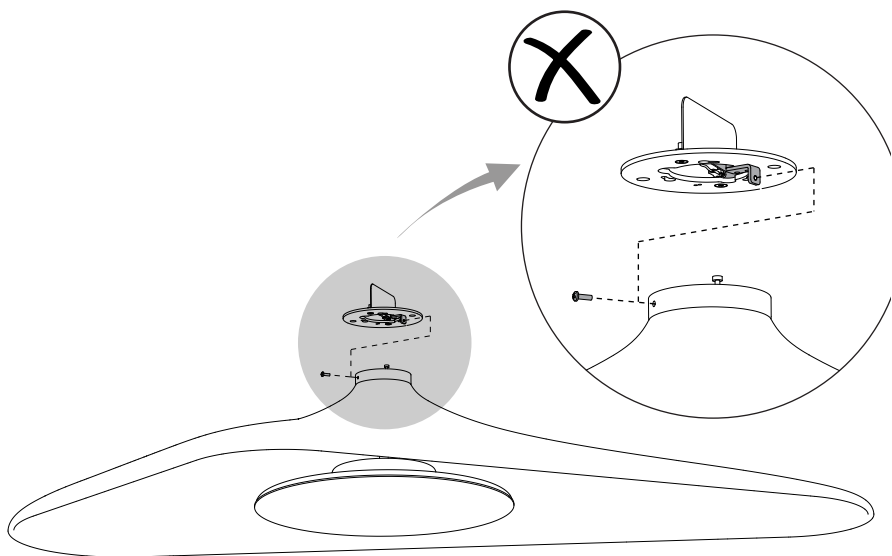
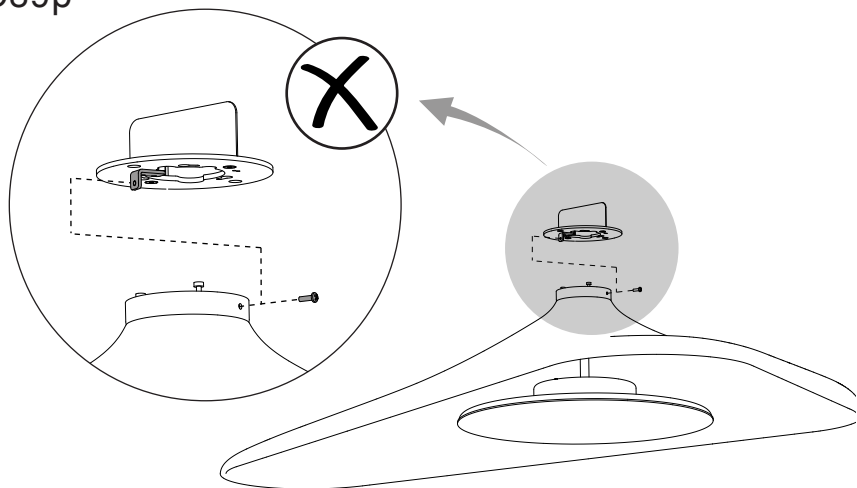



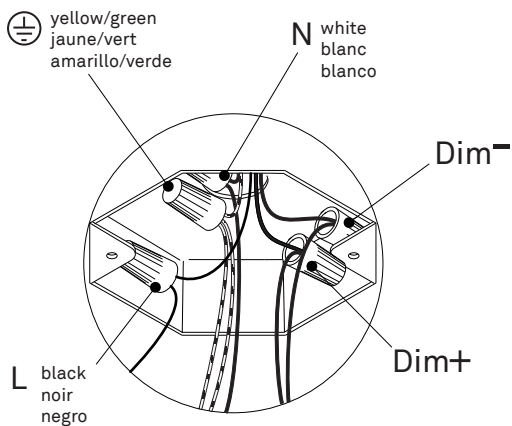
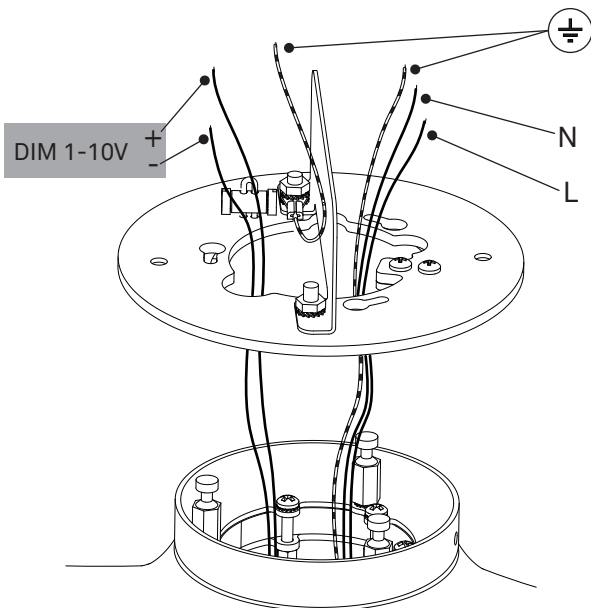
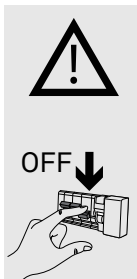

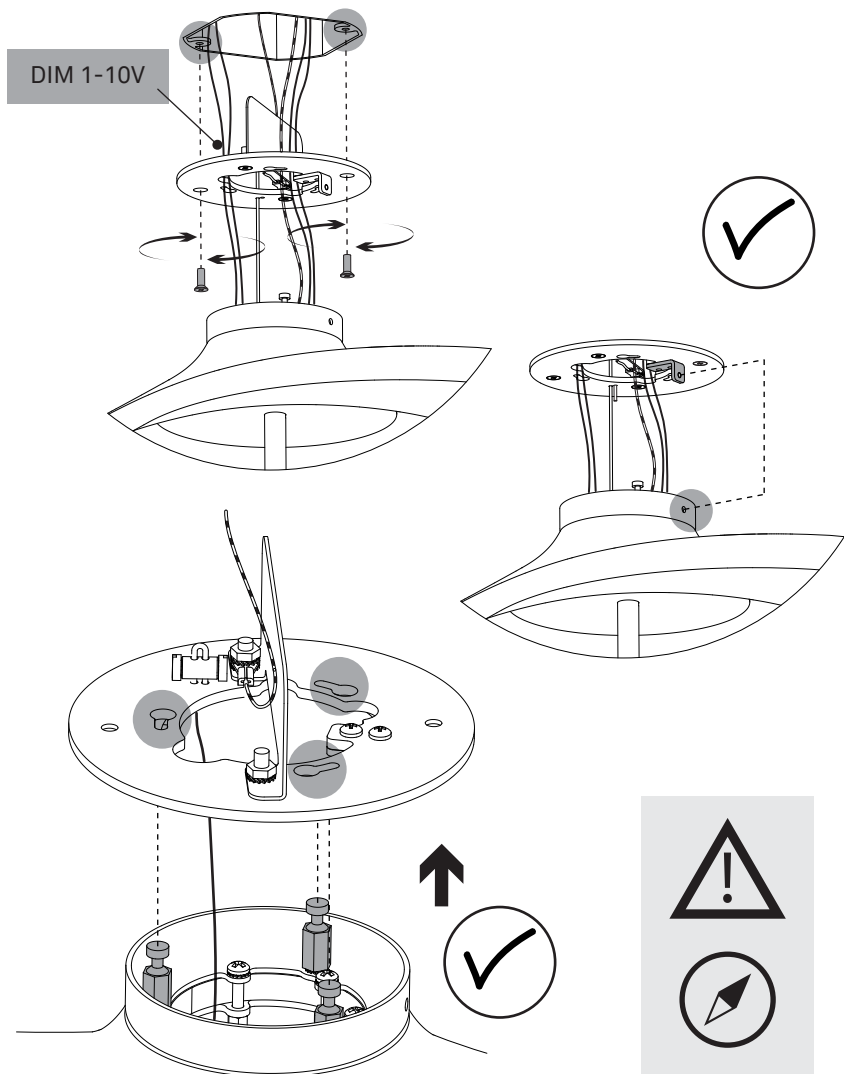

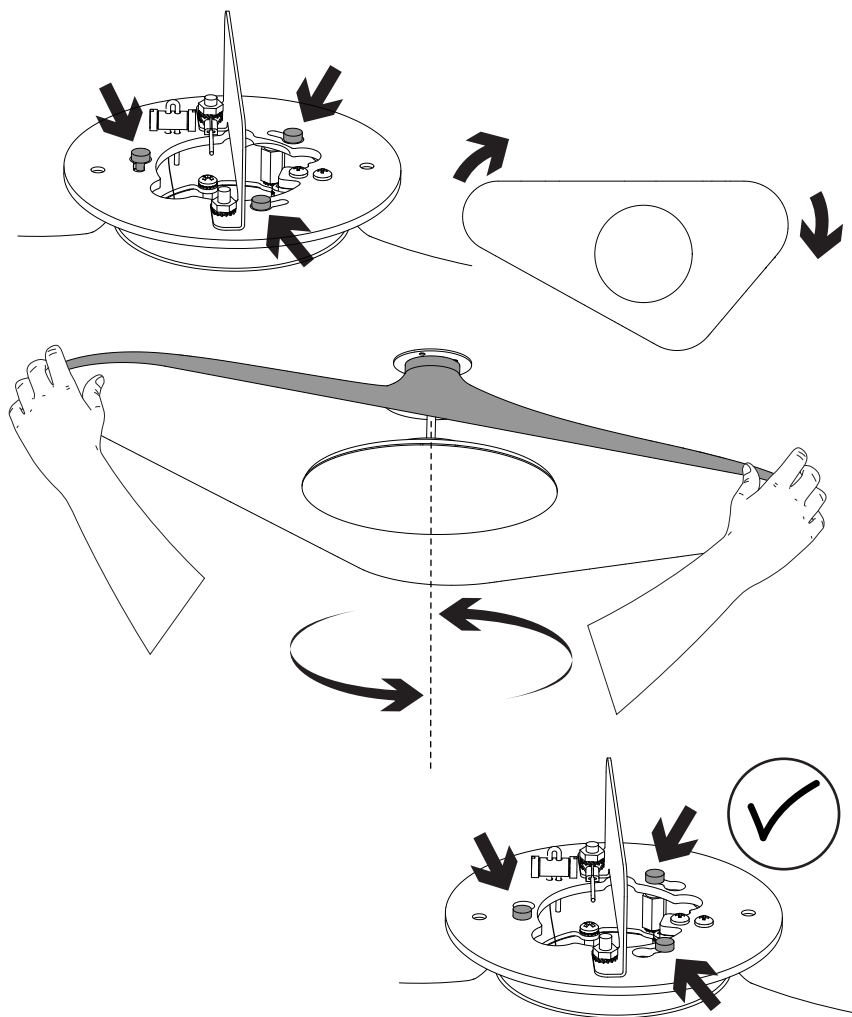

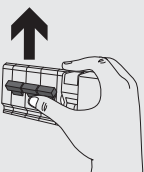
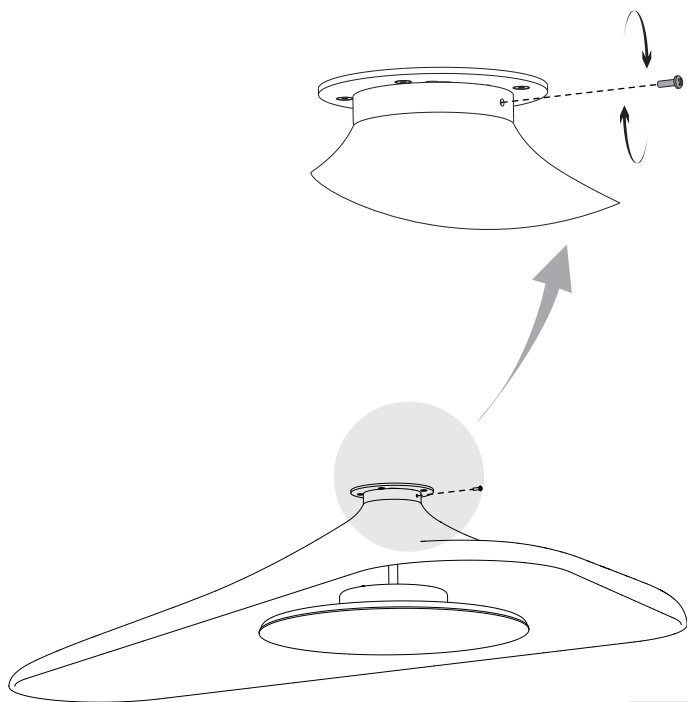

1

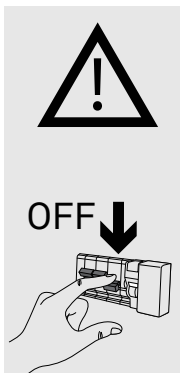
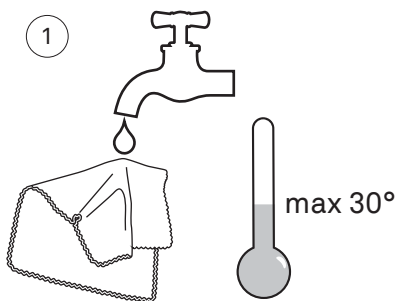

2

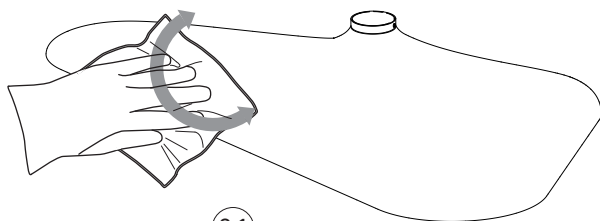

3.1

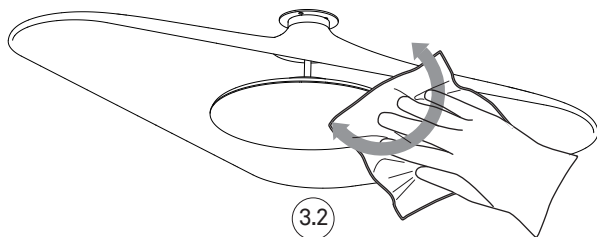

3.2







[www.luceplan.com](http://www.luceplan.com)

D890IA102