

HOPE

design Francisco Gomez Paz / Paolo Rizzatto

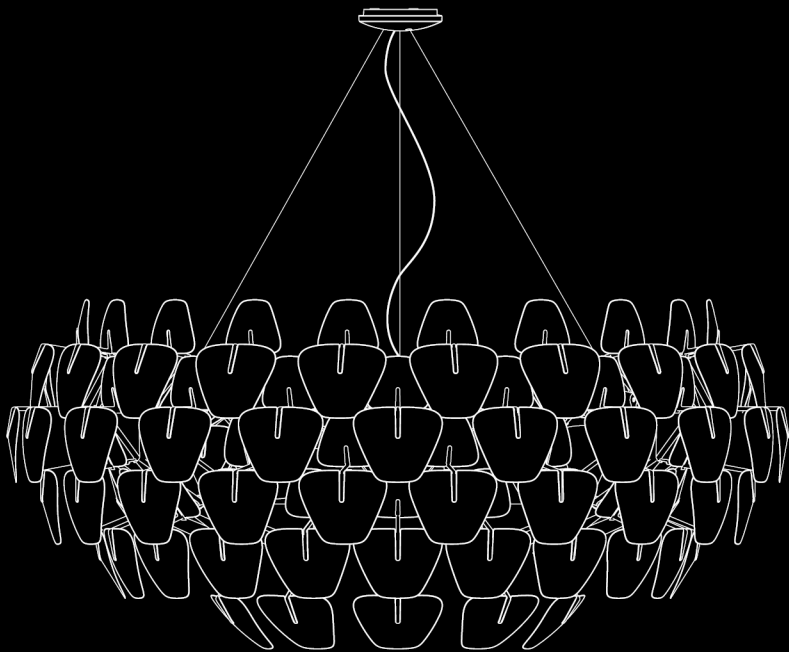

**LUCE
PLAN**

D66



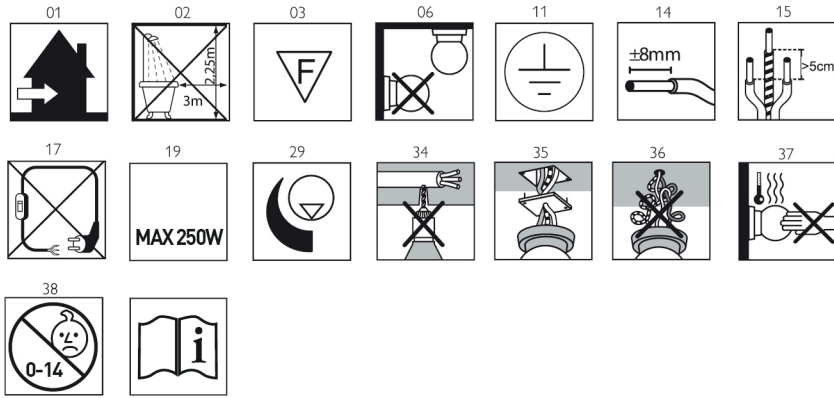

D66/105

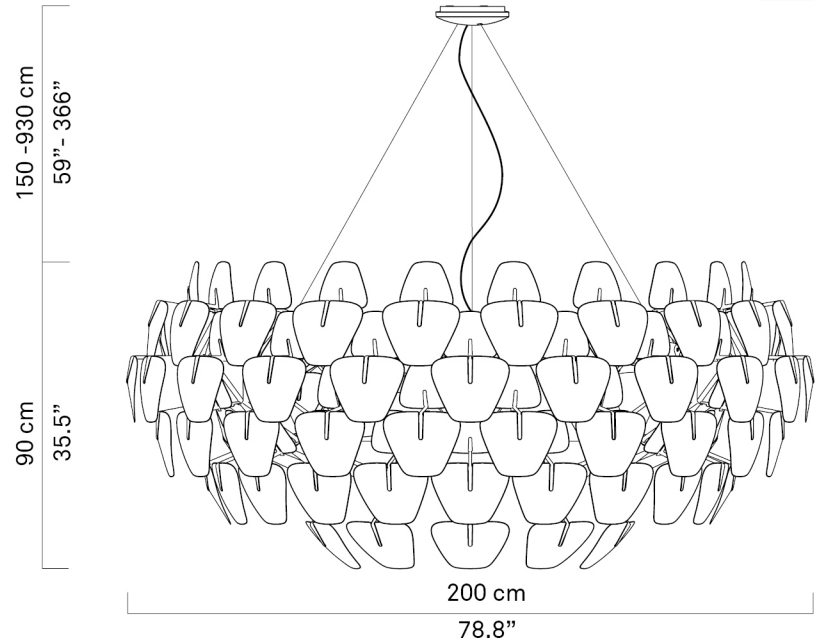
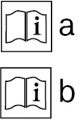

kg 18,7 kg **lb** 41.3 lb

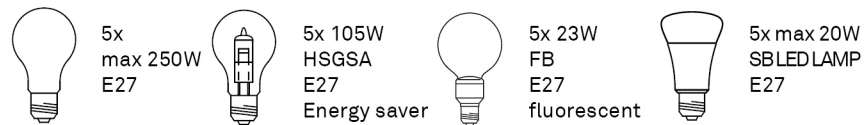



x 1



x 3

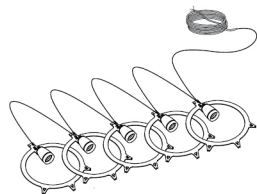

x 1



x 5



x 20

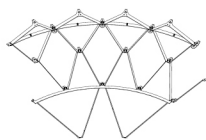

x 5



x 3



x 3



x 3



x 105



x 105



x 105



x 1



x 1



x 1



x 2

1

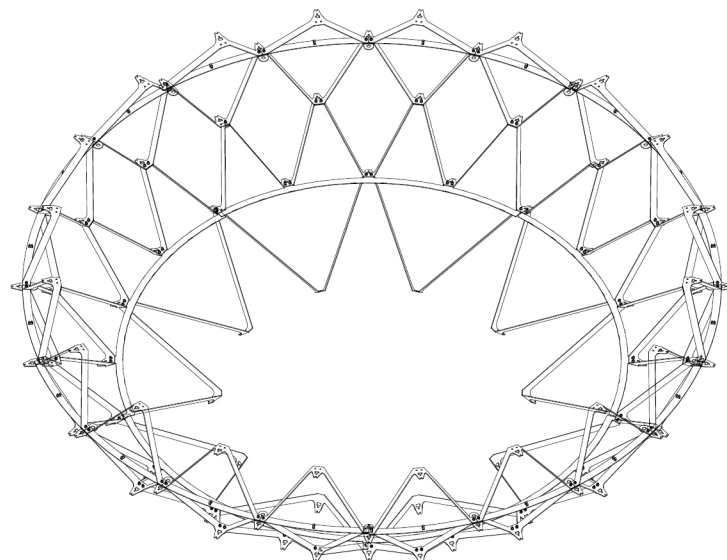
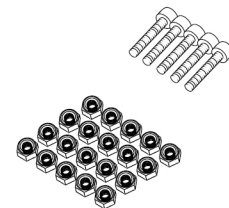
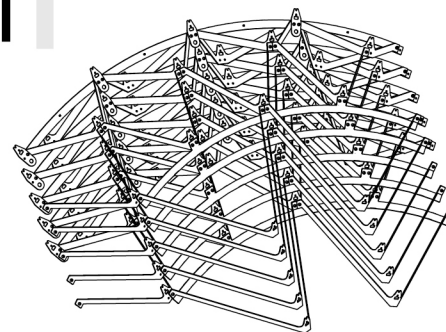

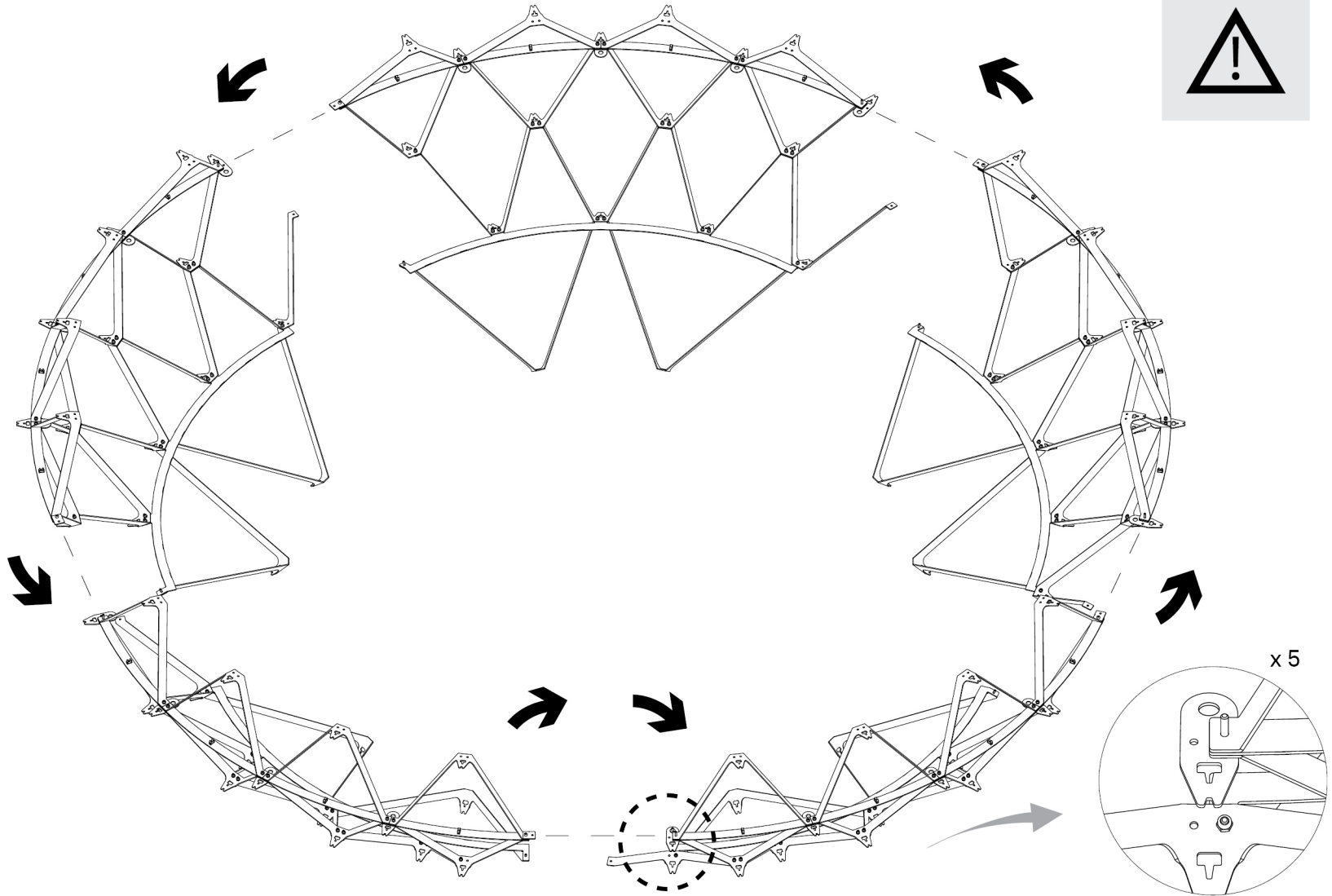

1.2

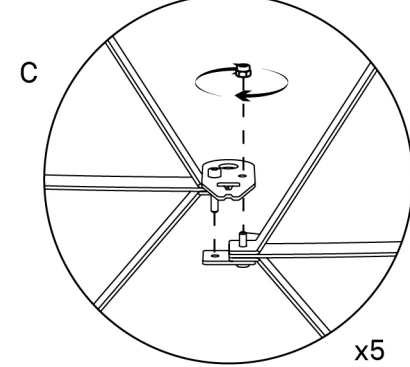
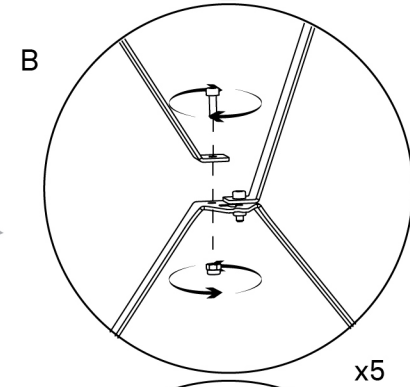
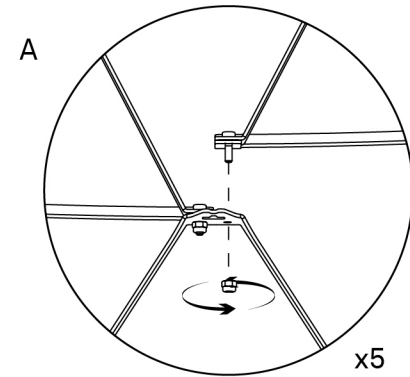
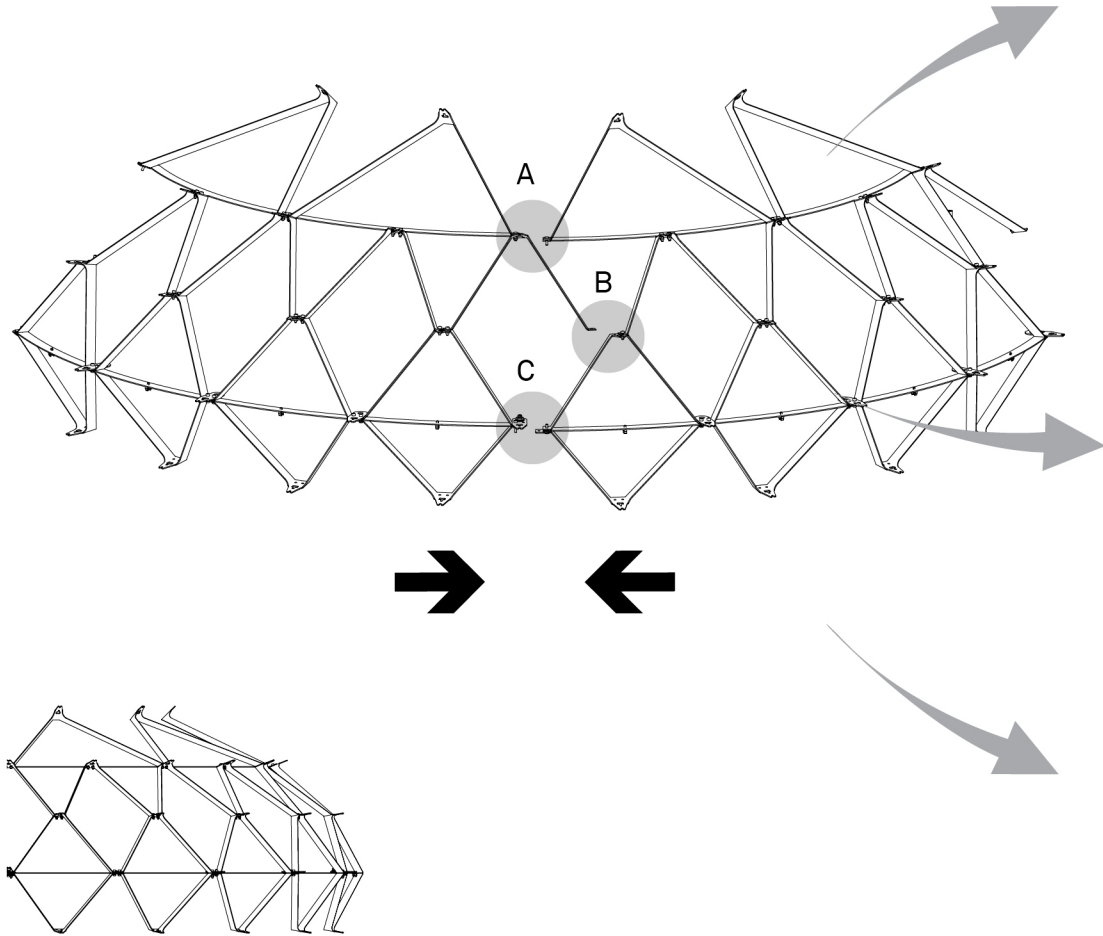

A vertical grey bar containing a warning triangle with an exclamation mark at the top. Below it are three icons: a hexagonal nut labeled 'B', a small cylindrical pin, and a long cylindrical rod labeled 'A'.

1.3

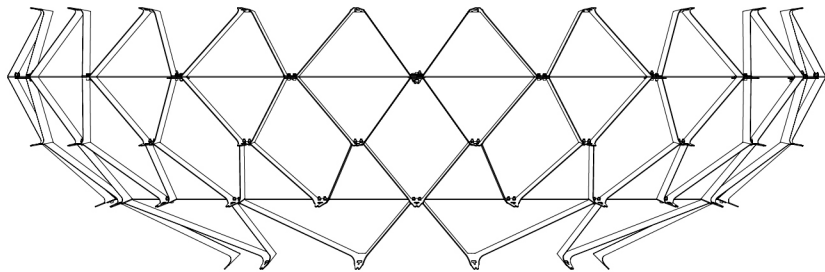
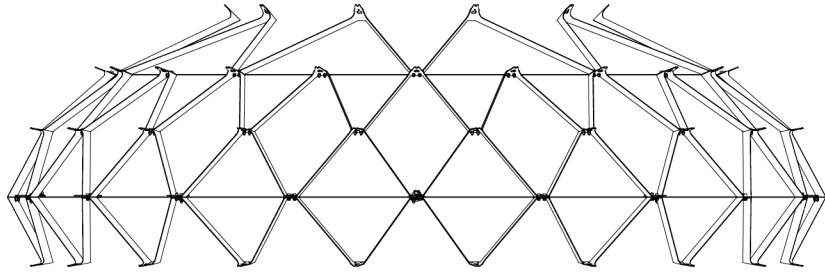

2

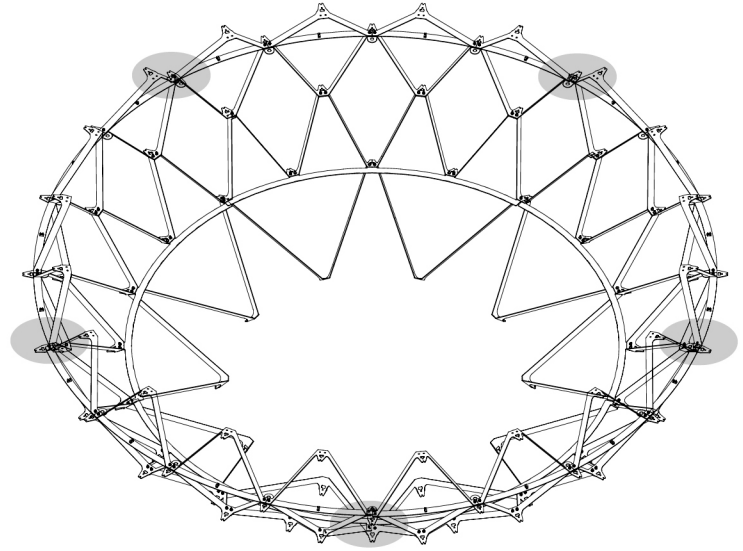
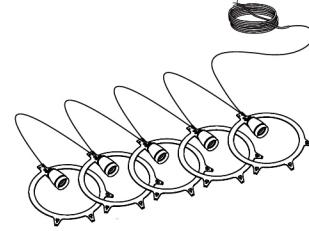

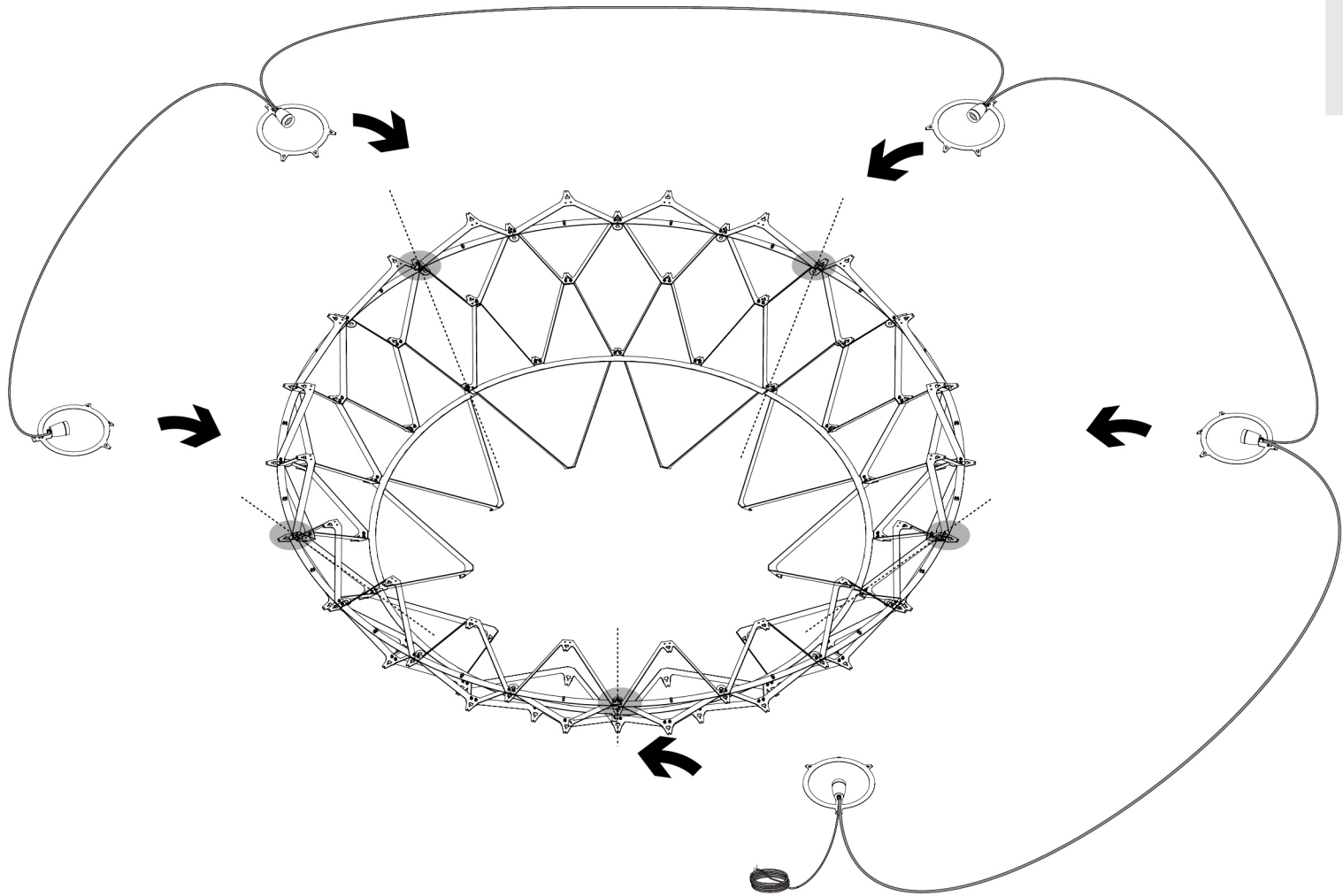

2.2

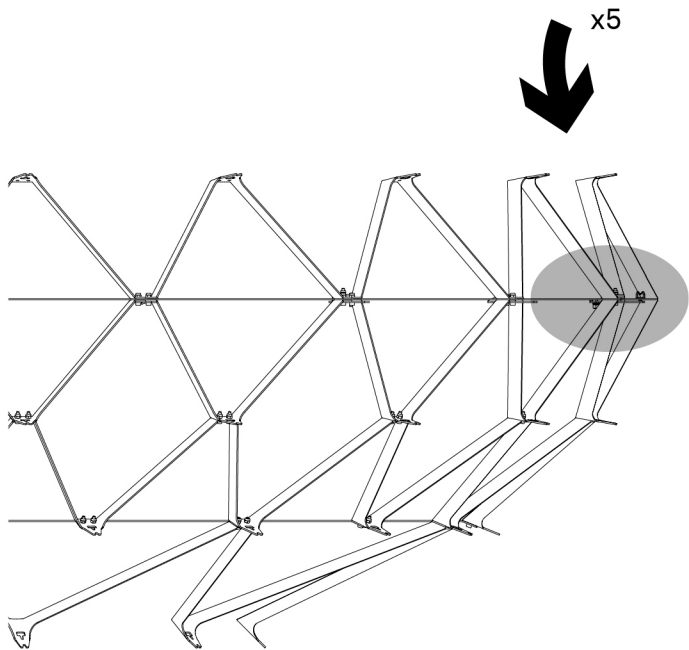
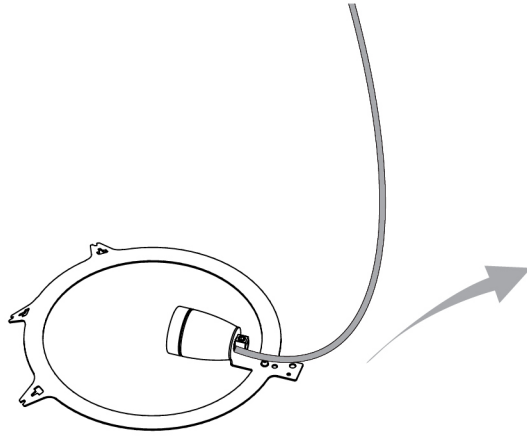

2.3

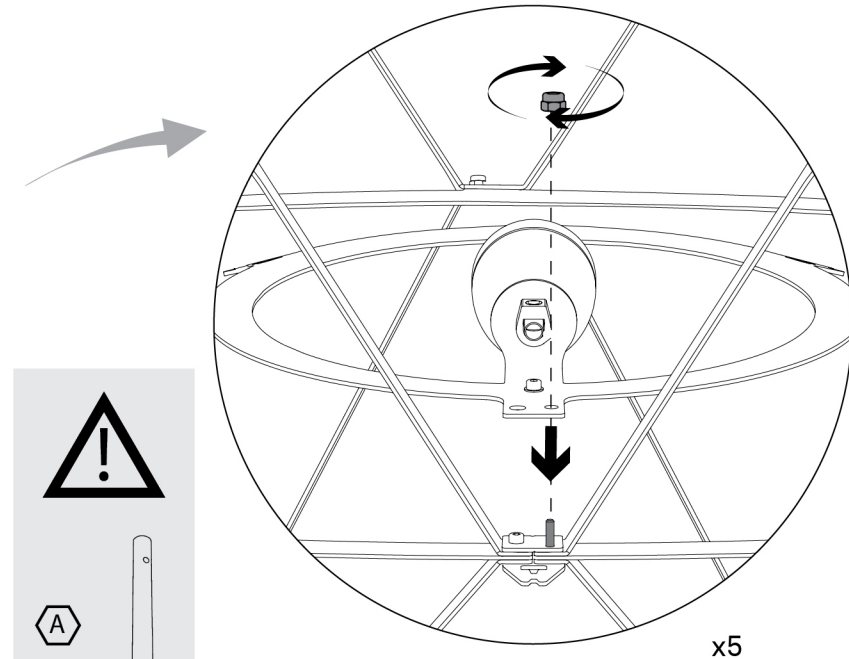

2.4 x15

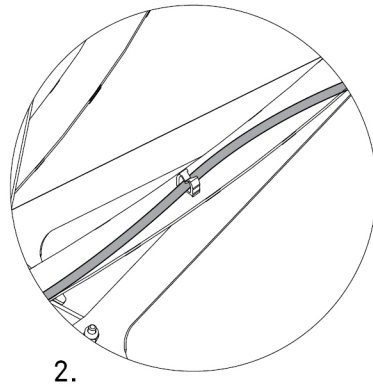
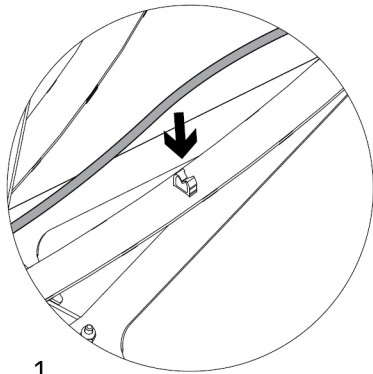
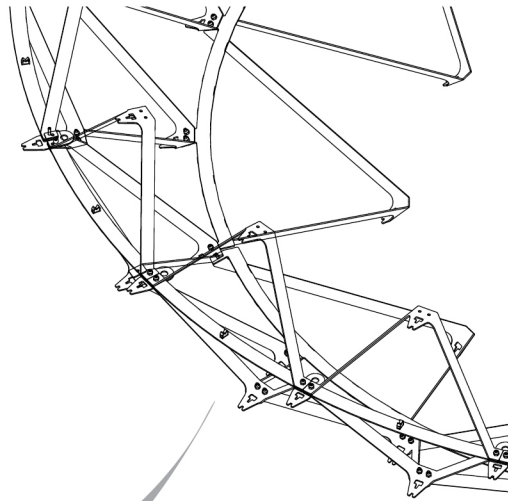

3

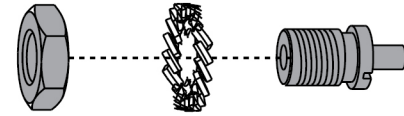

x3

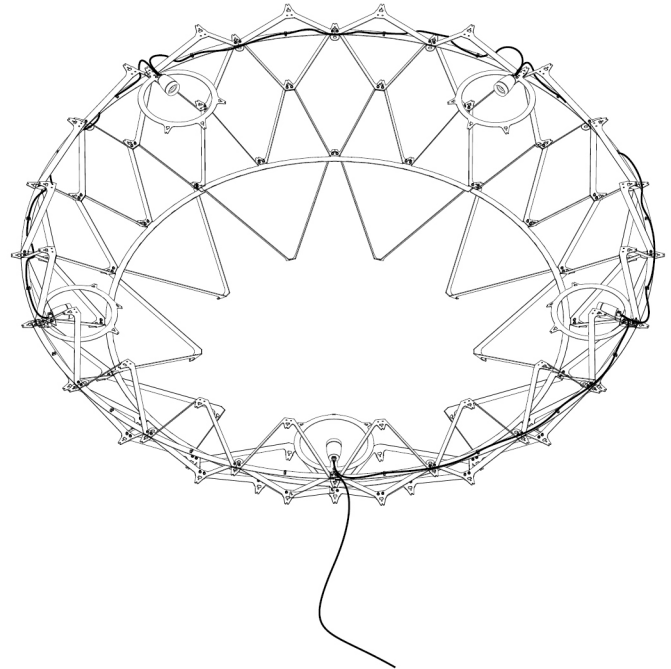

3.1

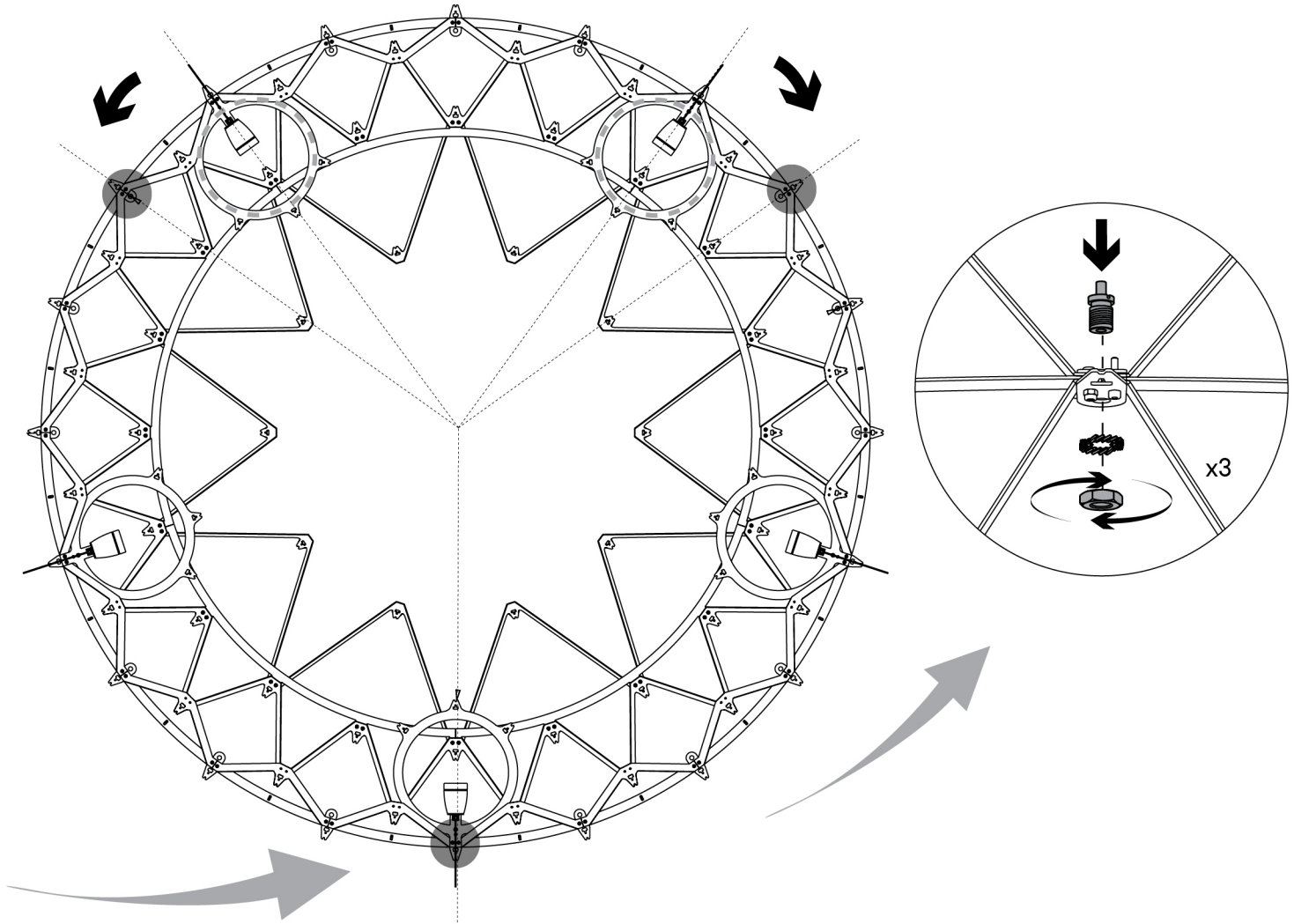

4

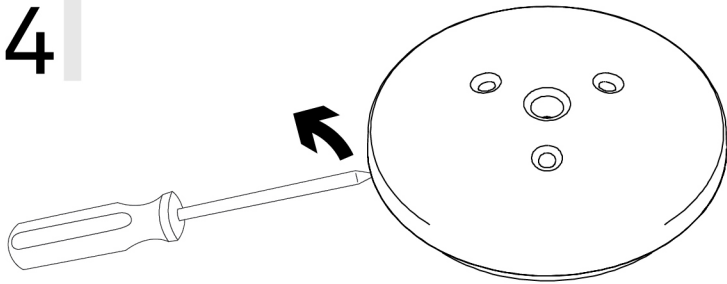

4.1

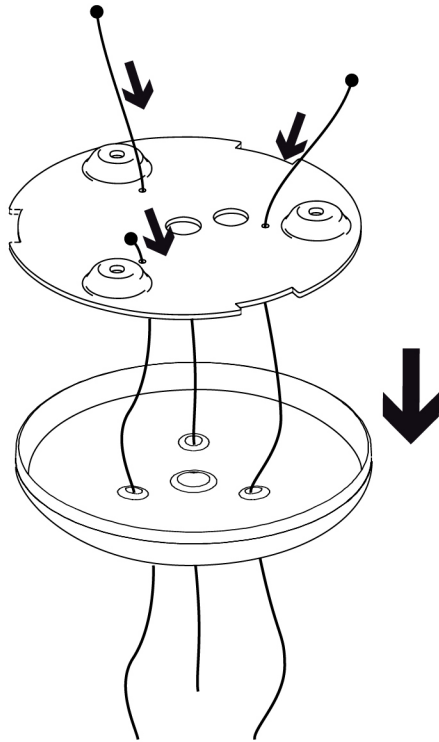

4.2

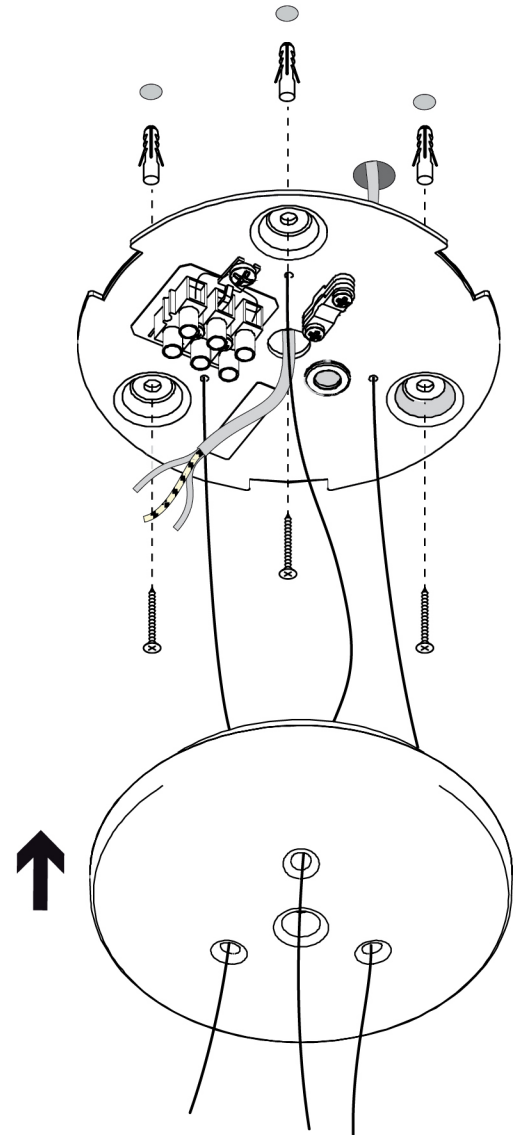
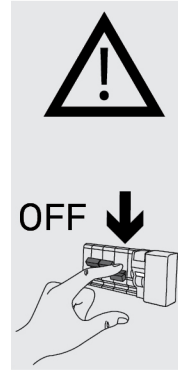

4.3

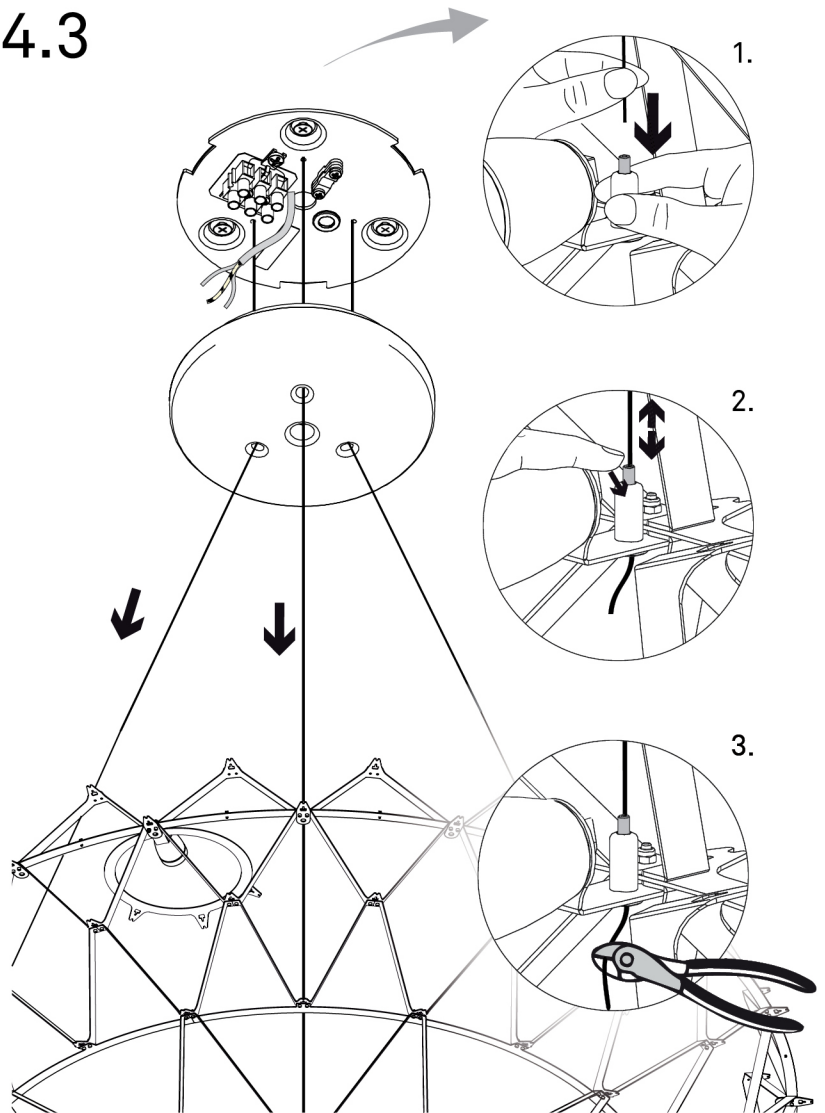

4.4

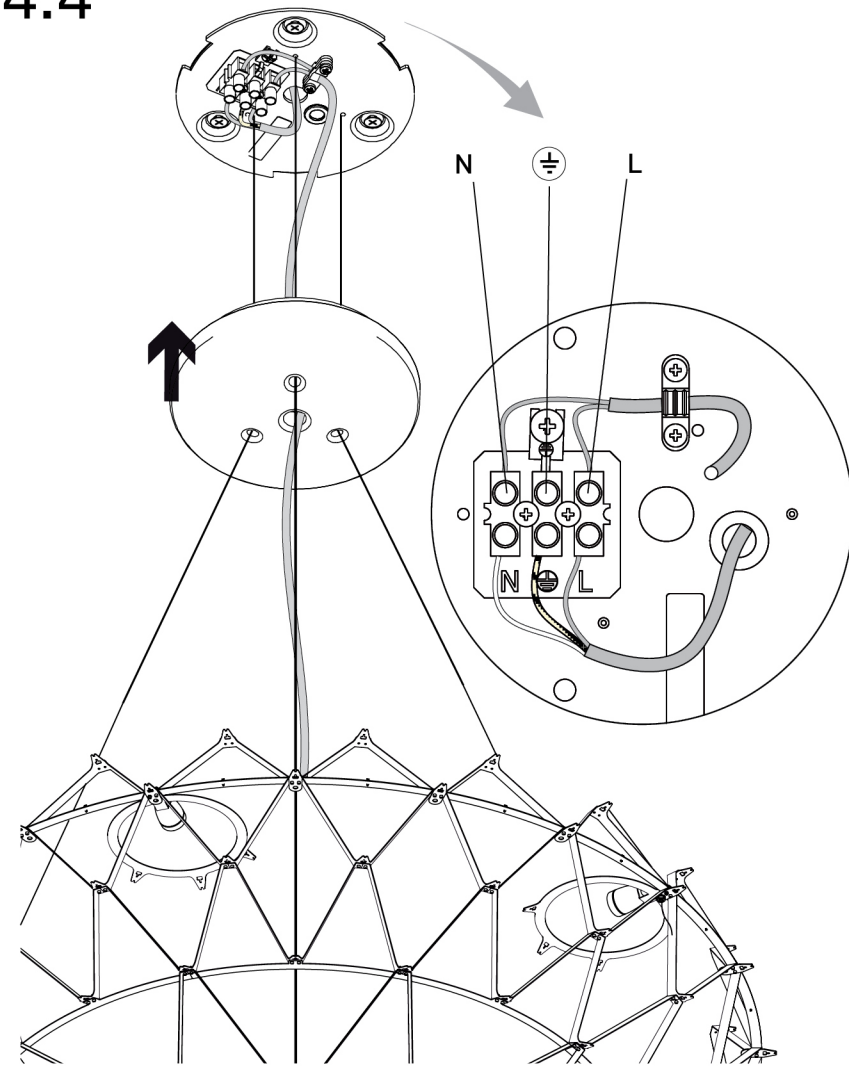

4.5

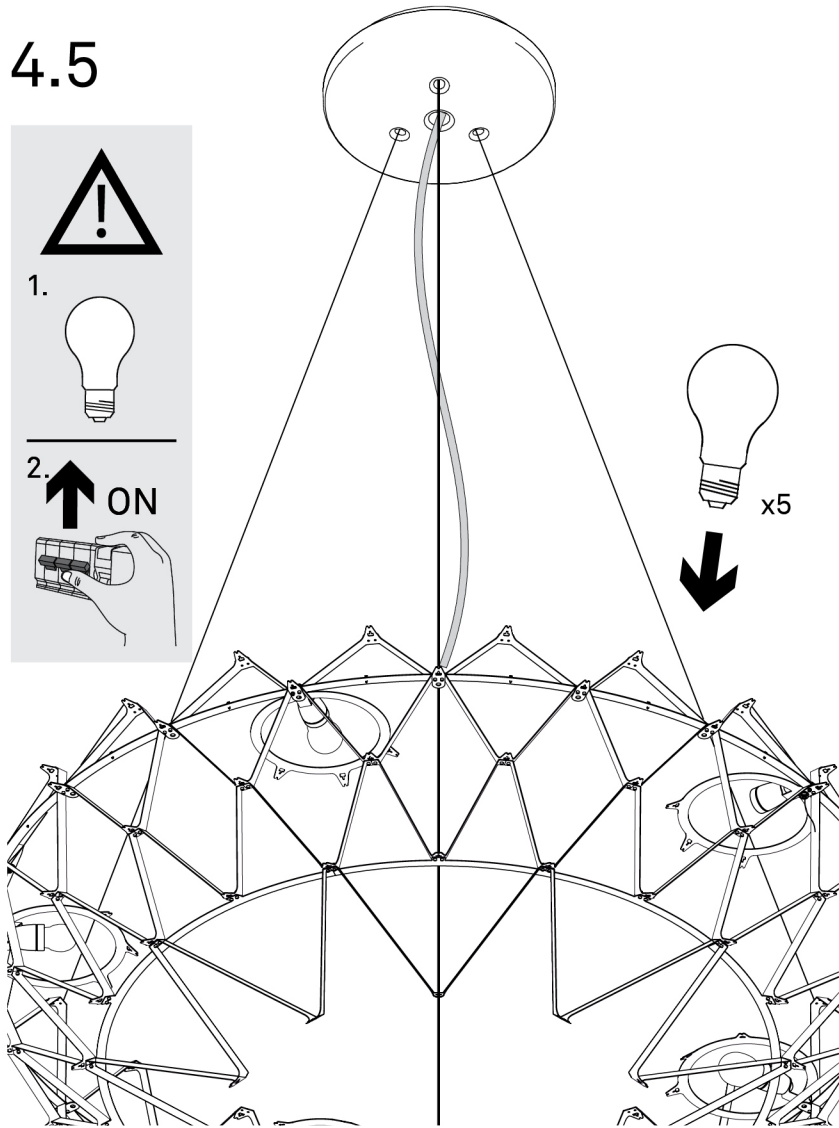
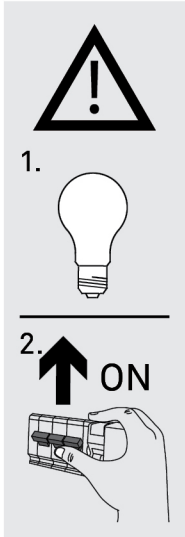

5

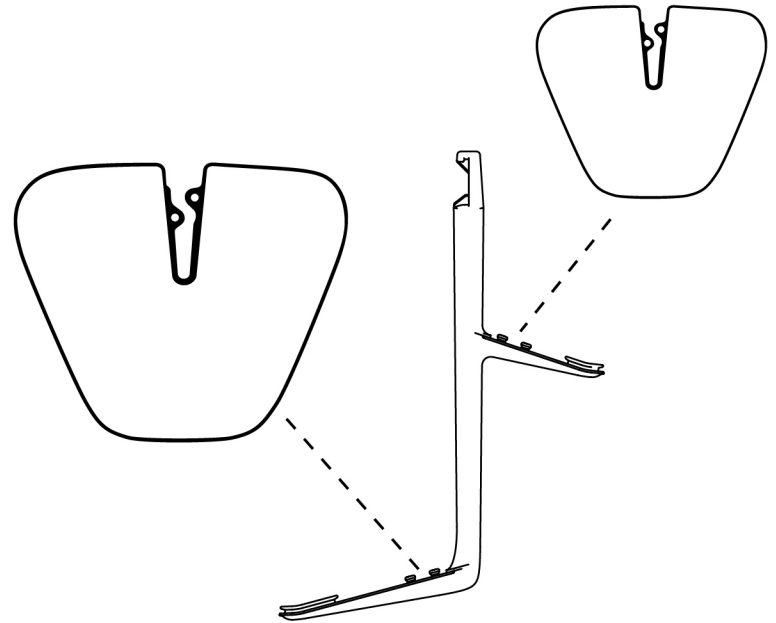

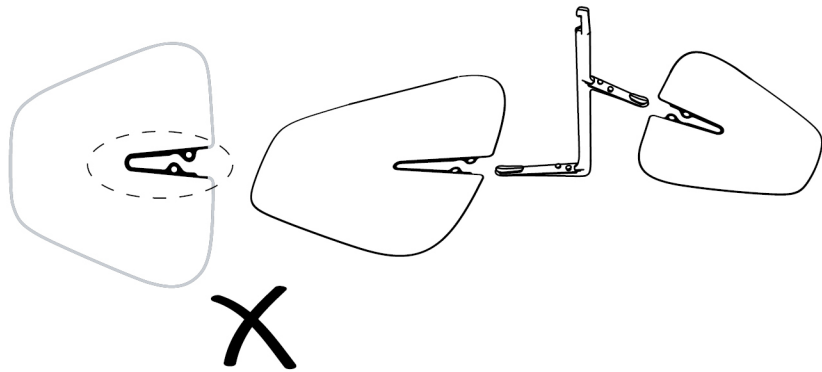
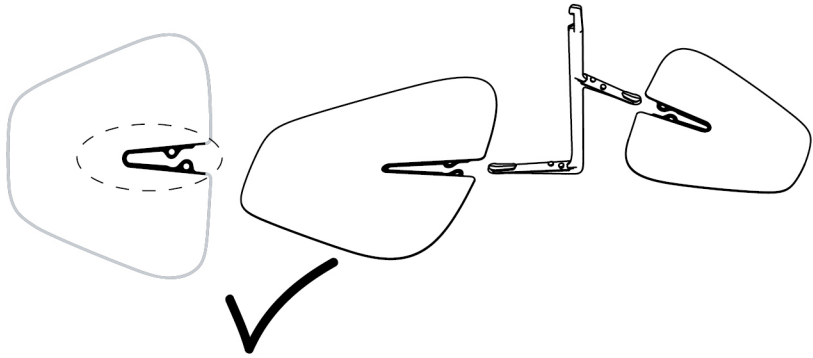

5.1

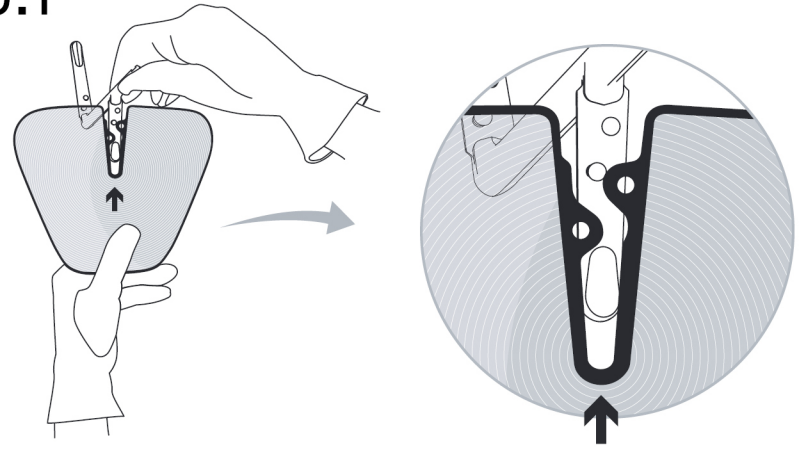

5.2

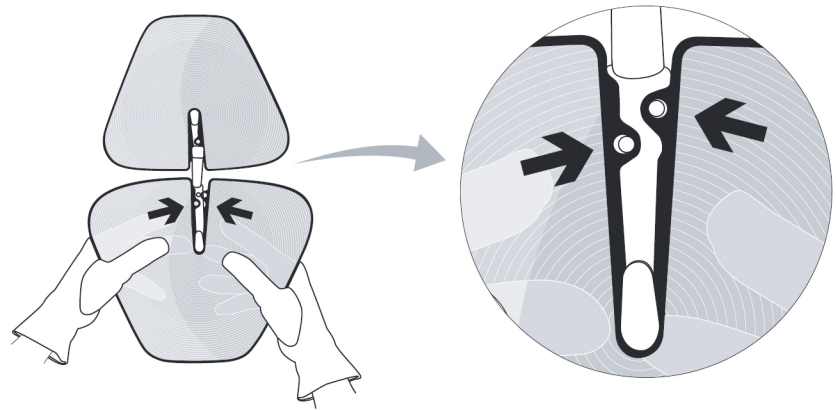

6

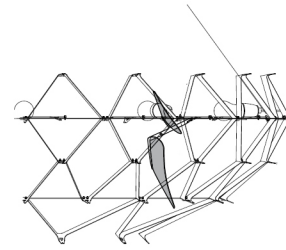
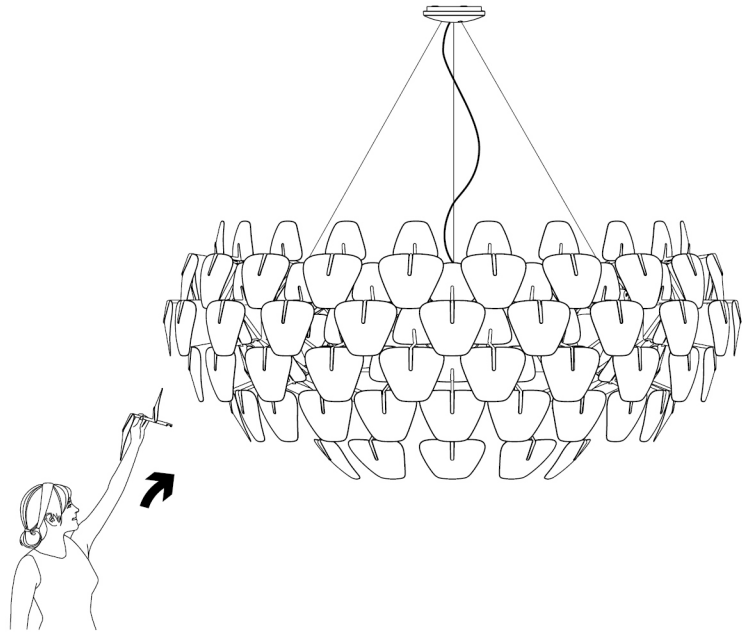

1.

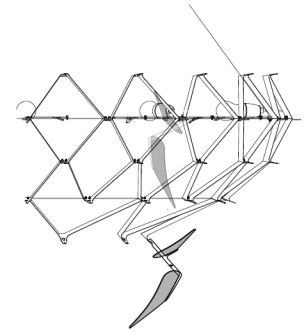

2.

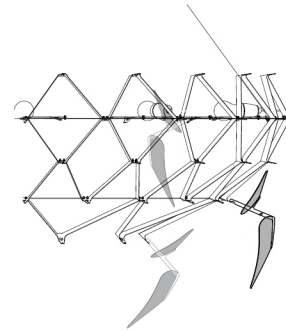

3.

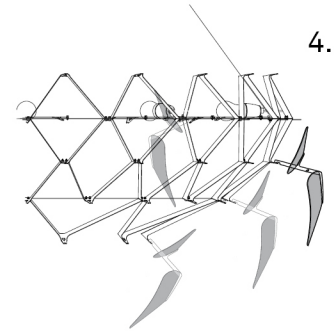

4.

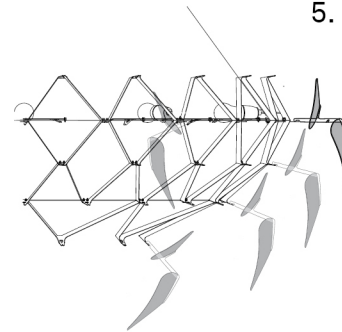

5.

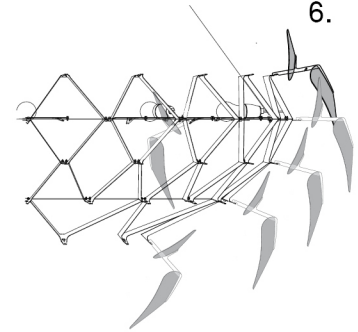

6.

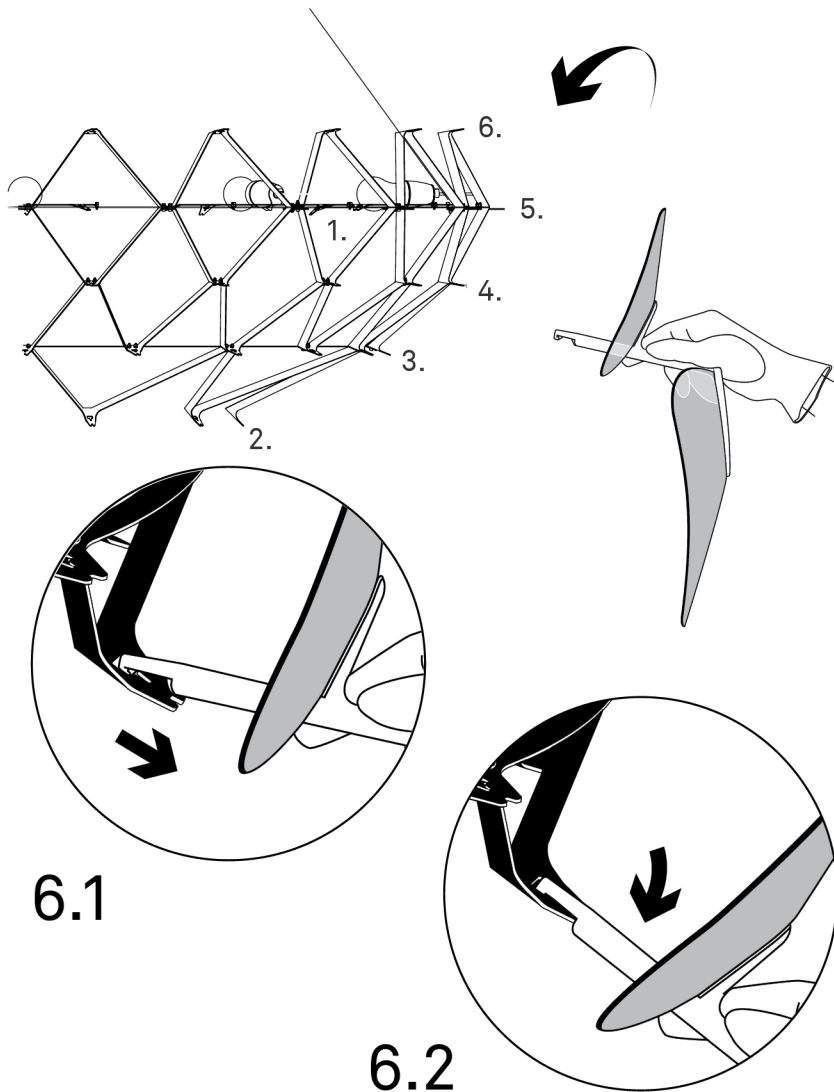

7

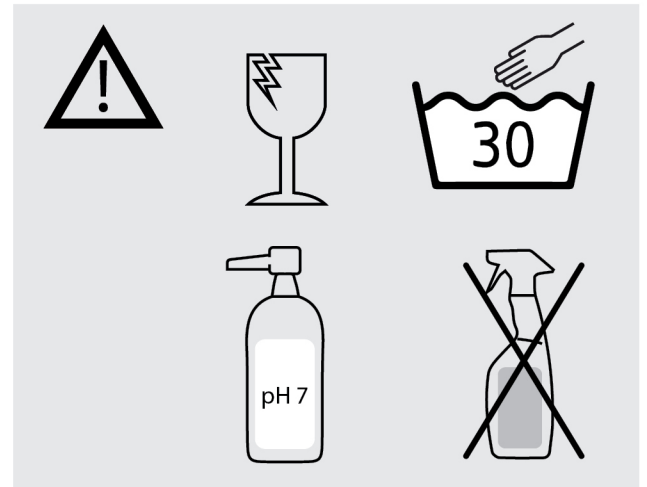

x1

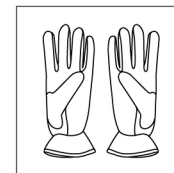

x2

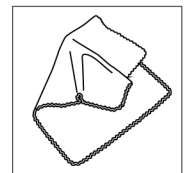

7.1

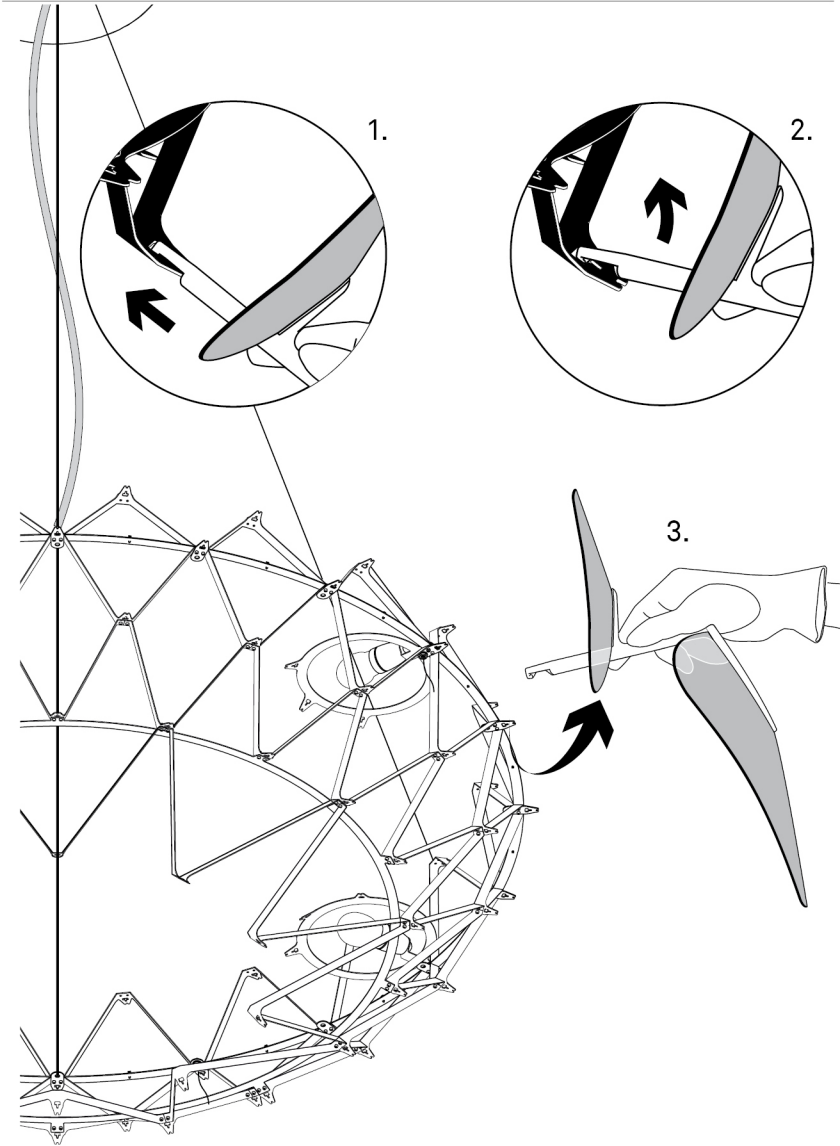
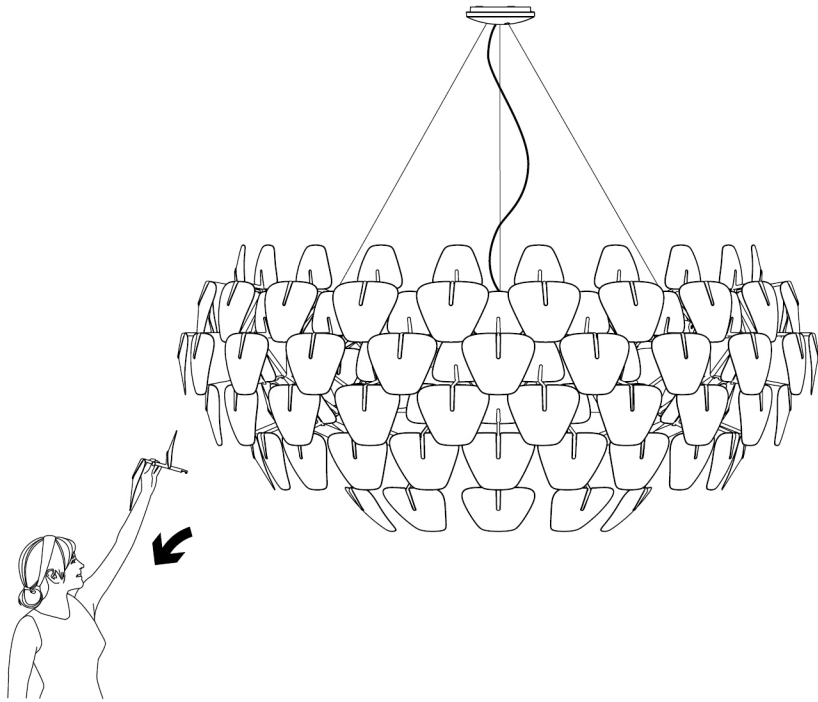

7.2

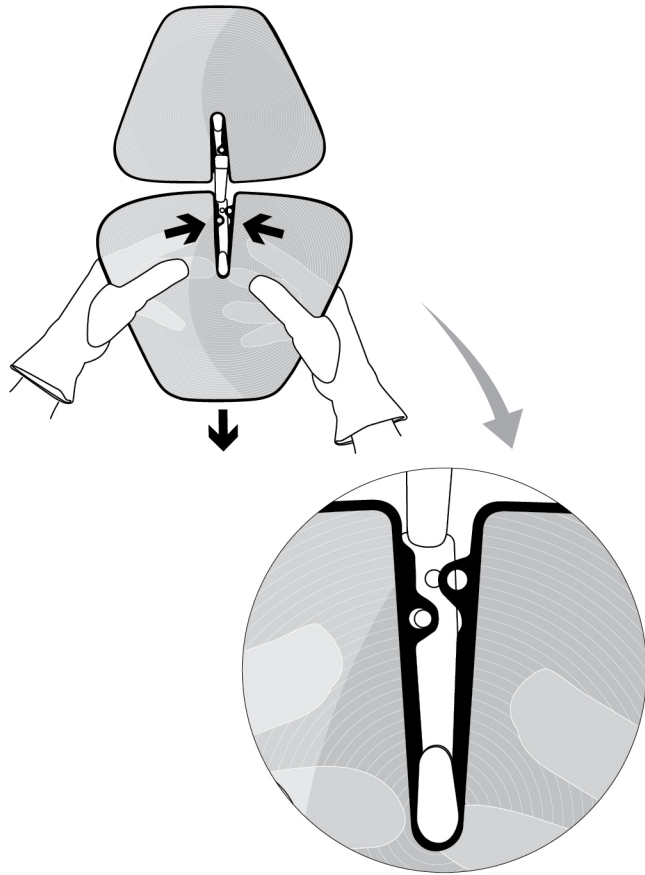

7.3

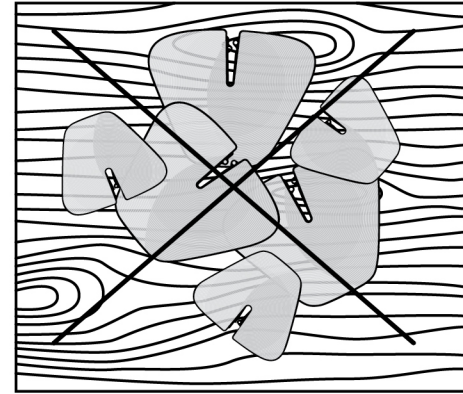

X

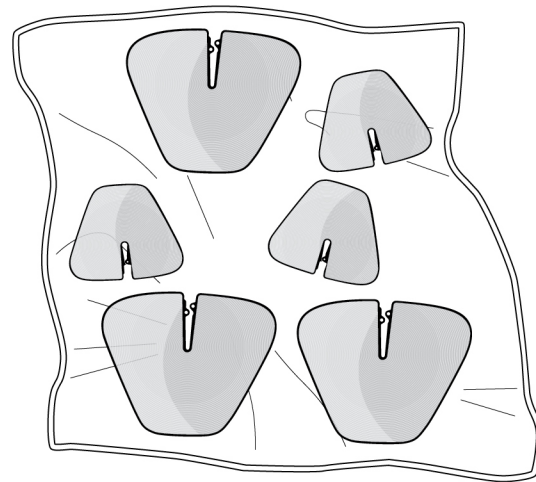

✓

7.4

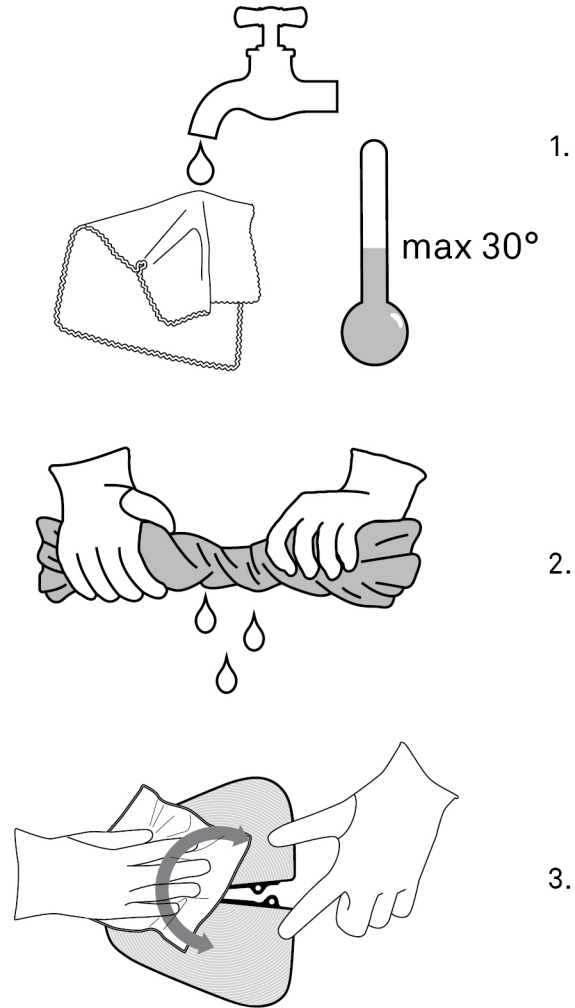

➔ **5** |
(p. 25)



www.luceplan.com

D660I0213