

# E04

design Habits Studio

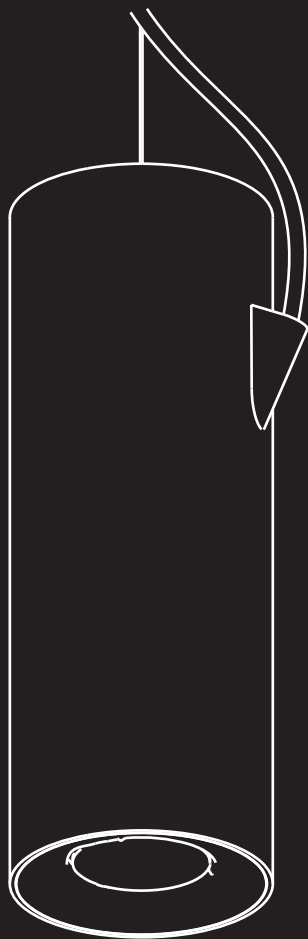

**LUCE  
PLAN**

---

E04



# E04270 + E041M-E041W-E043M-E043W

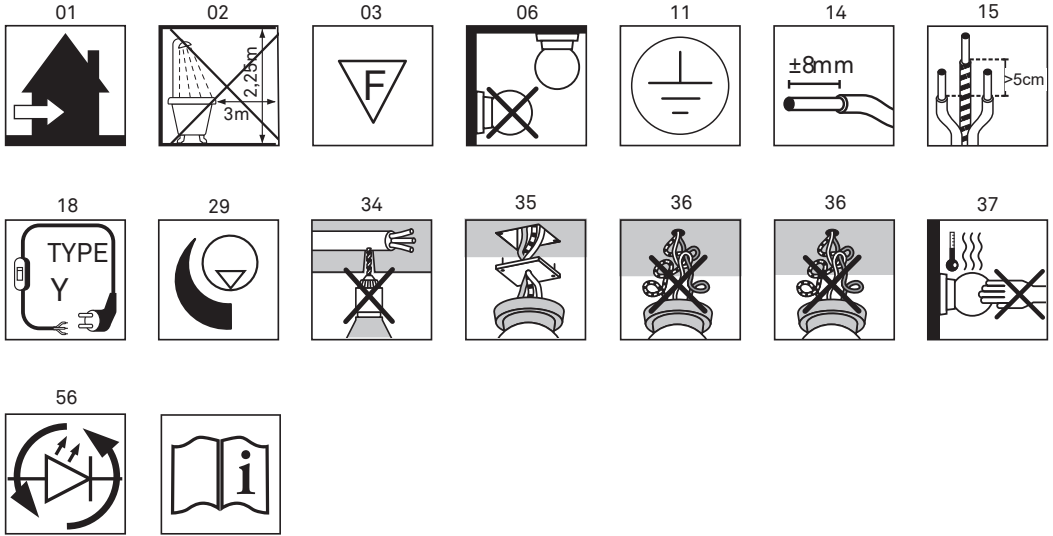

# E04280 + E041M-E041W-E043M-E043W

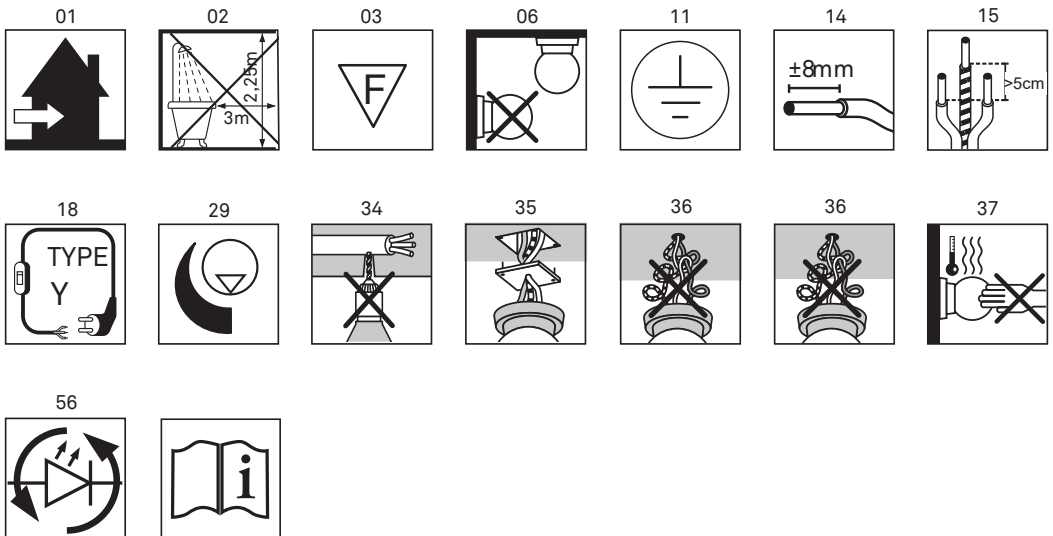

# E04290 + E042M-E042W-E044M-E044W

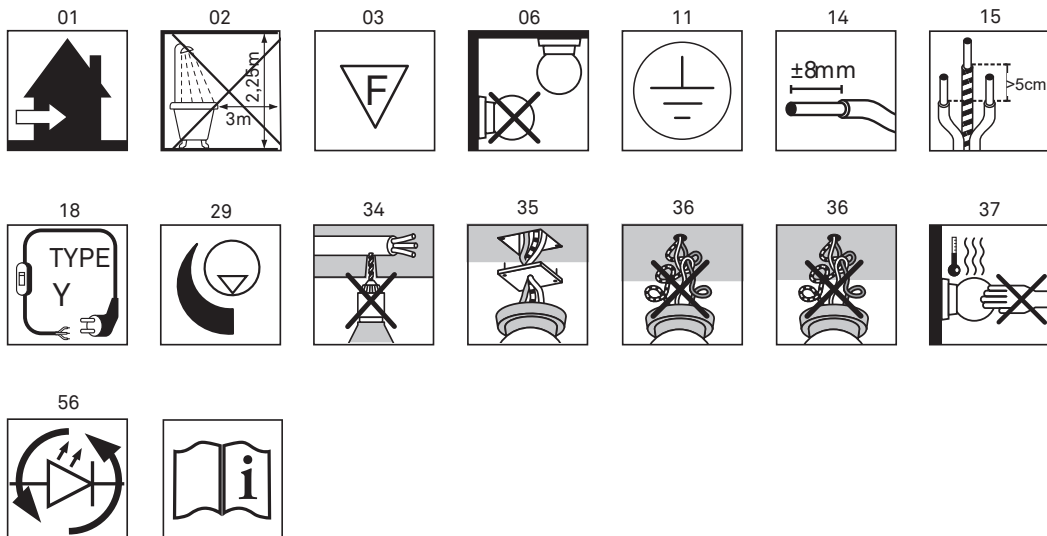

# E04270 + E041R

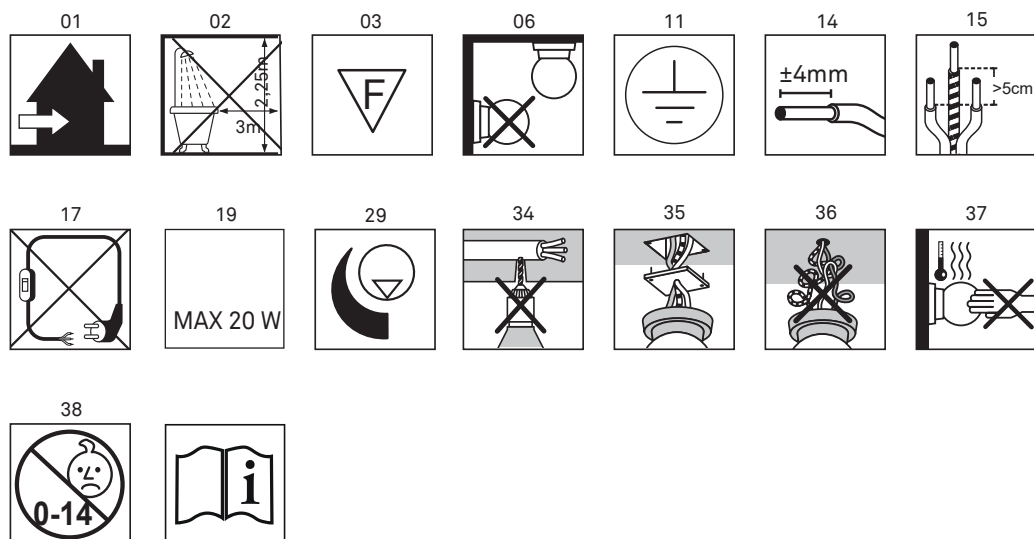

# E04280 + E041R

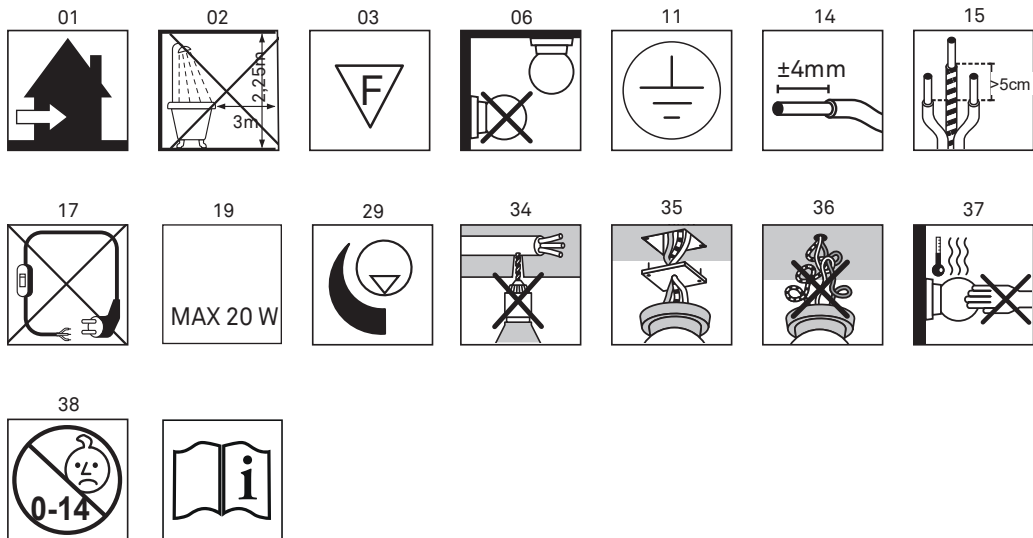

# E04290 + E042R

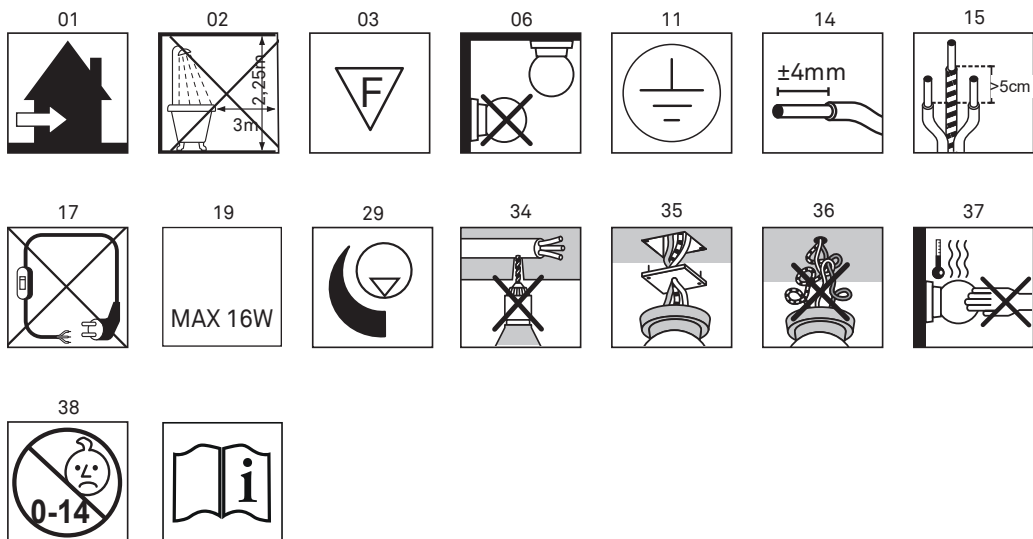

# E04270

max 300 cm - min. 30 cm

max 118.11" - min. 0.98"

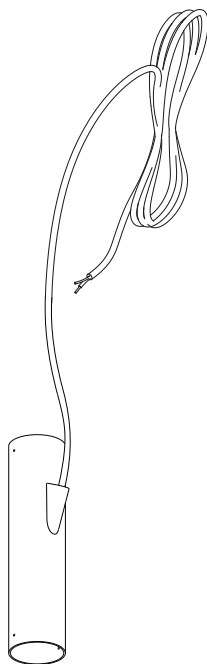
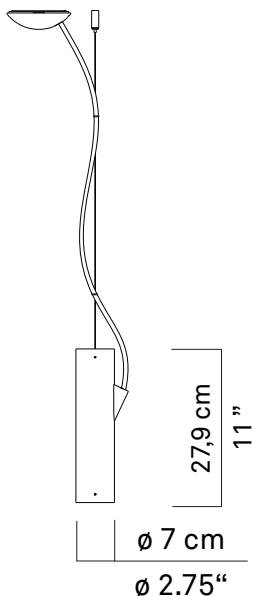

x1



x1



a



b

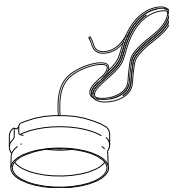

x1



x1



x3



x1



x4

# E041M-E041W-E043M-E043W

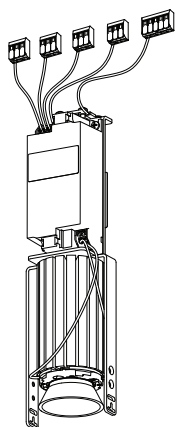

x1



x1

**kg** 0,95 kg **lb** 2,09 lb

# E04280

max 300 cm - min. 50 cm

max 118.11" - min. 1.60"

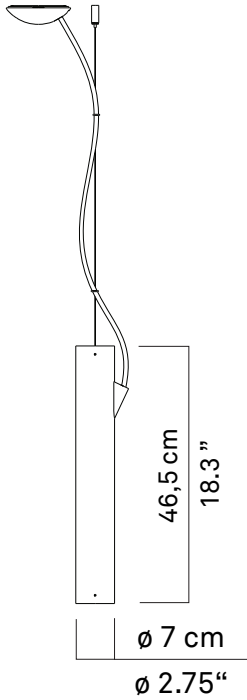

x1



x3



x1



x1



x1



a



b

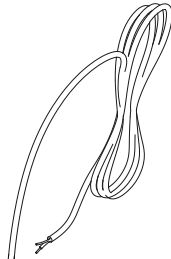

x4



x4

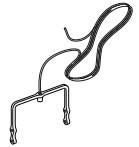

x1

# E041M-E041W-E043M-E043W

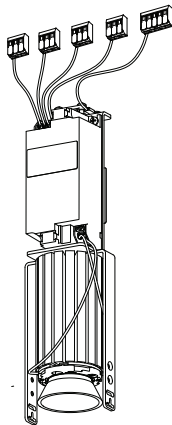

x2



x2

kg 2 kg

lb 4,4 lb

# E04290

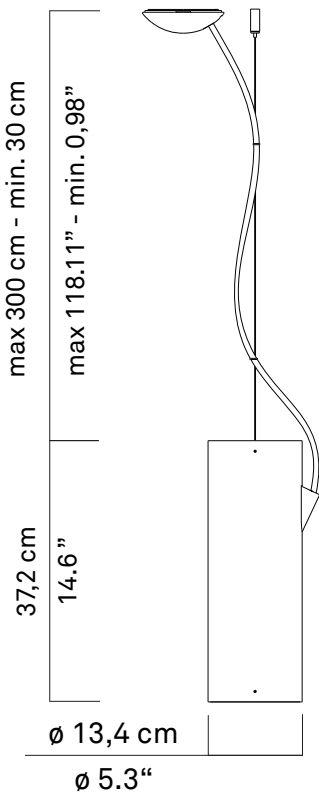

x3



x1



x1



x4

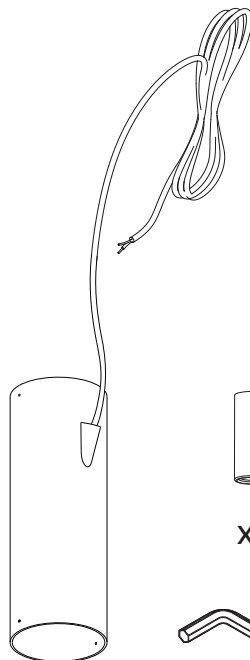

x1



x1



x1



a



b

# E041M-E041W-E043M-E043W

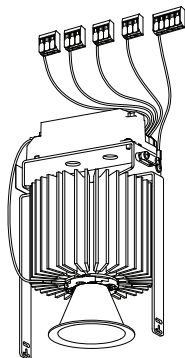

x1

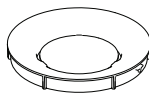

x1

kg 2,3 kg

lb 5,07 lb

# E04270

max 300 cm - min. 30 cm

max 118.11" - min. 0.98"

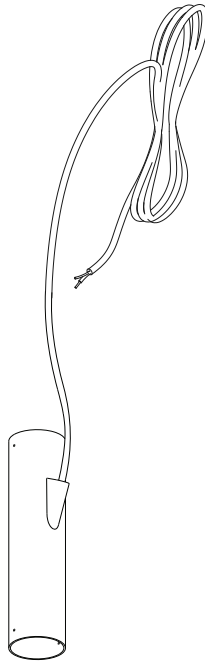
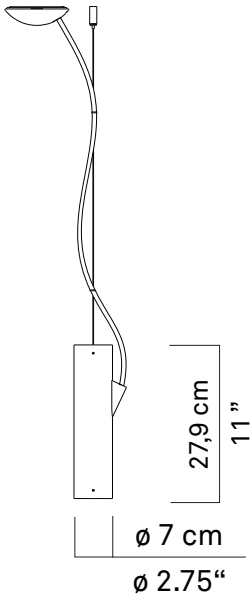

x1



x1



a



b

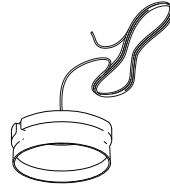

x1



x1



x3



x1



x4

# E041R

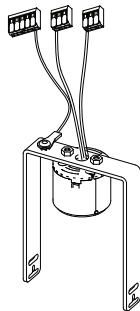

x1



x1



x2

kg 0,8 kg

lb 1,8 lb



# E04280

max 300 cm - min. 50 cm

max 118.11" - min. 1.60"

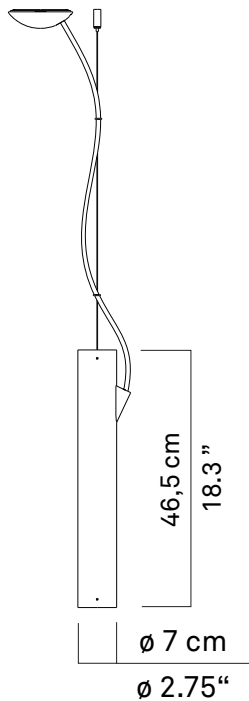

x1



x3



x1



x1



x1



a



b



x4



x4



x1

# E041R

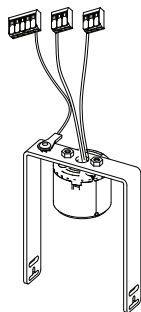

x2

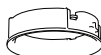

x2



x2

kg 1 kg

lb 2,2 lb

# E04290

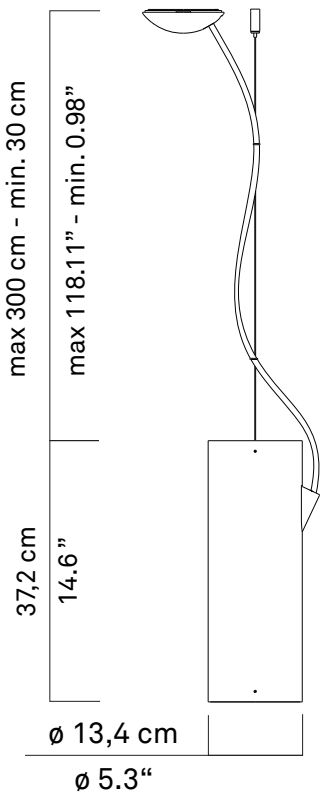

x3



x1



x1



x4

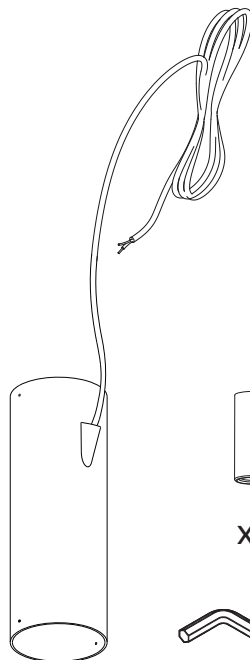

x1



x1



x1



a



b

# E042R

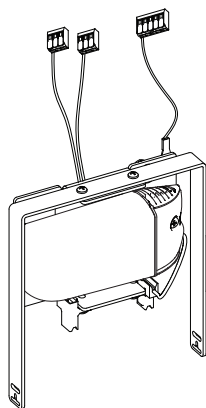

x1

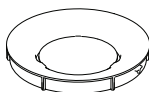

x1



x2

kg 2,0 kg

lb 4,40 lb

---

# EA1096

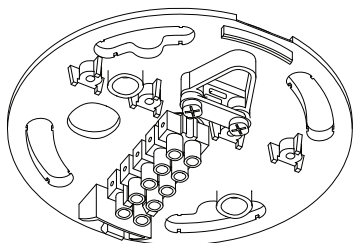

x1

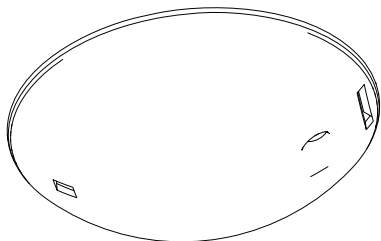

x1



# 1 E04270 - E04280 - E04290 + EA1096

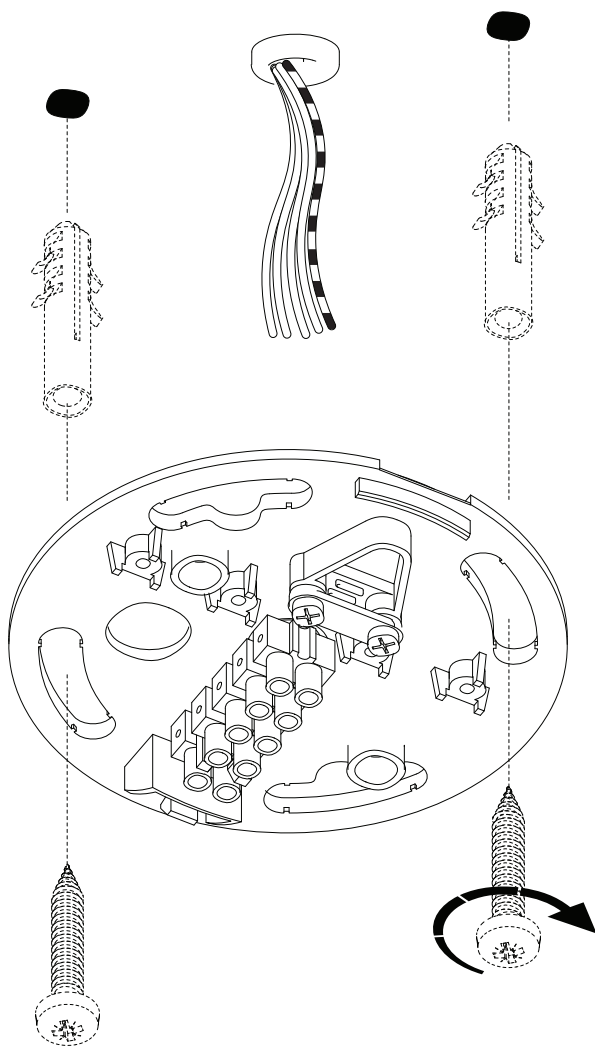
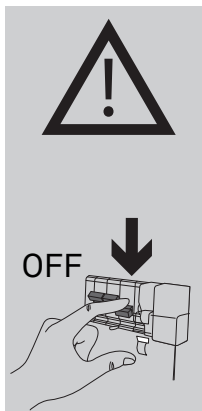

# 2

E04270

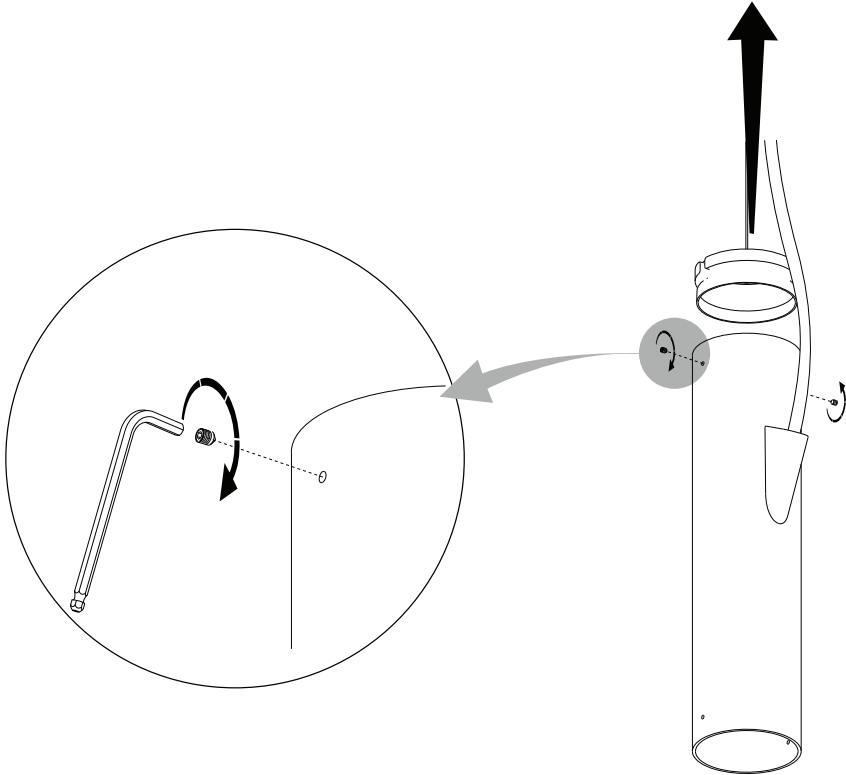

---

# 2.1 E04270

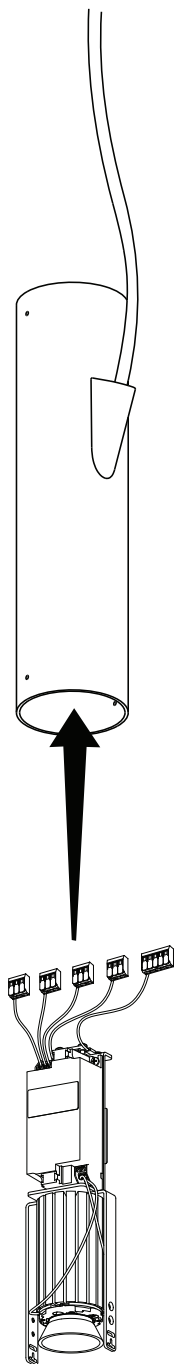

# 2.2 E04270

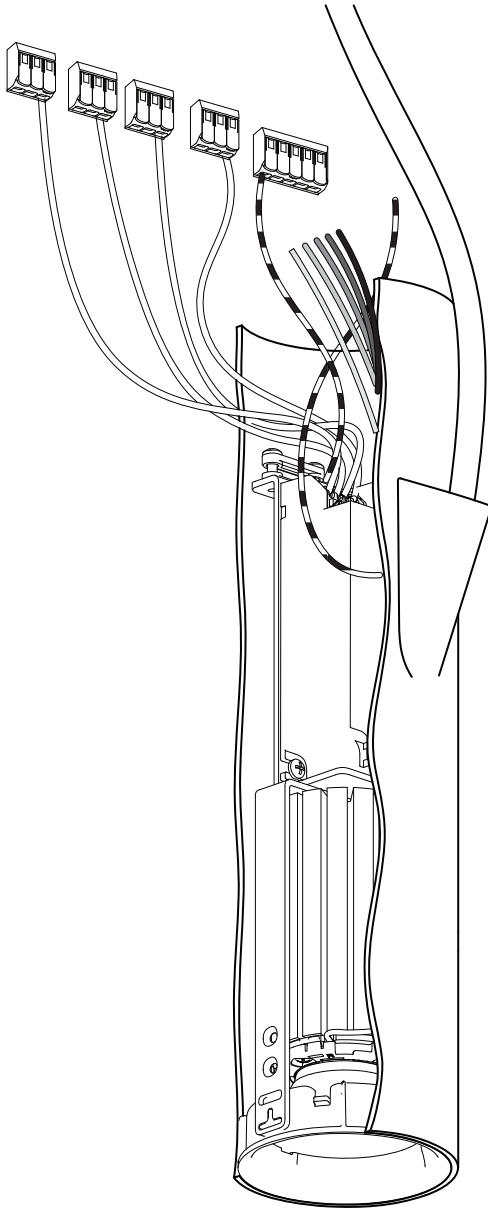



## 2.3 E04270

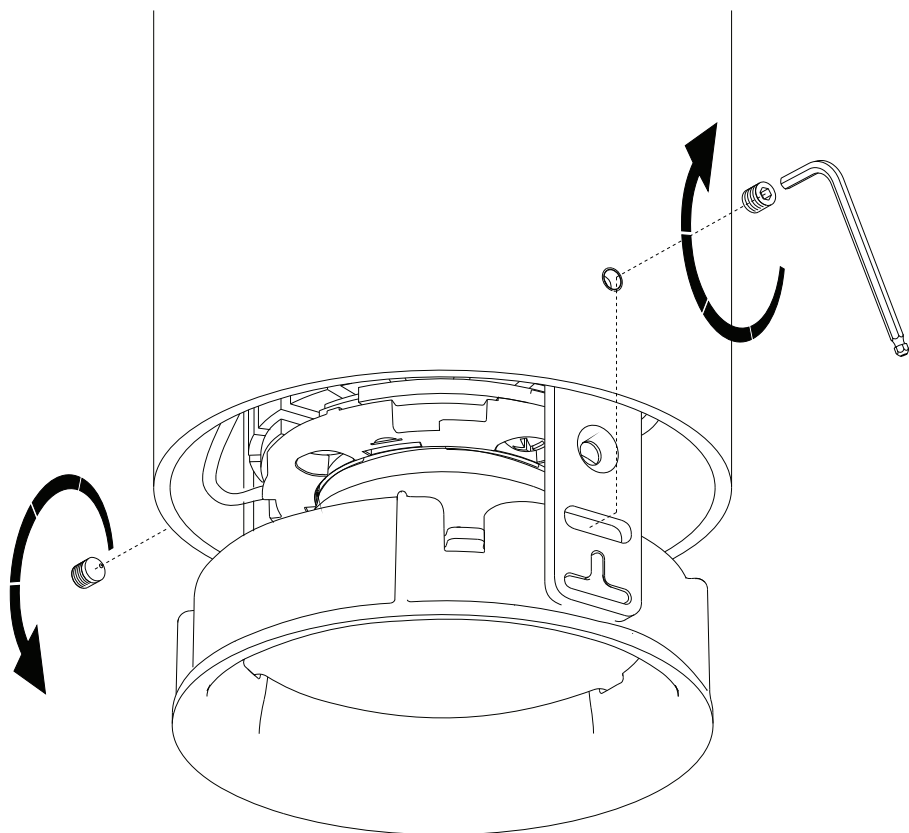

# 2.4 E04270

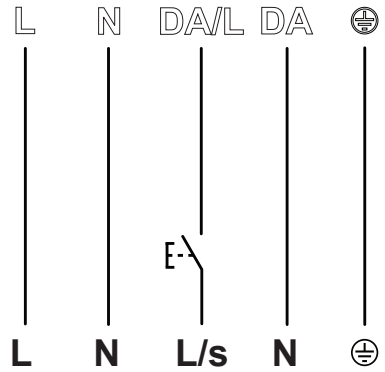
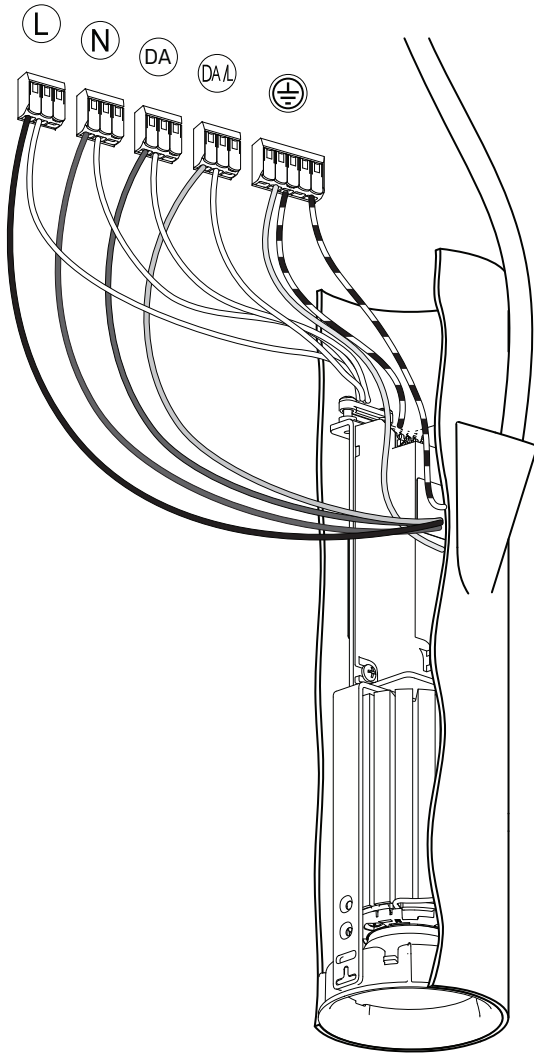

PUSH DIM



# E04270

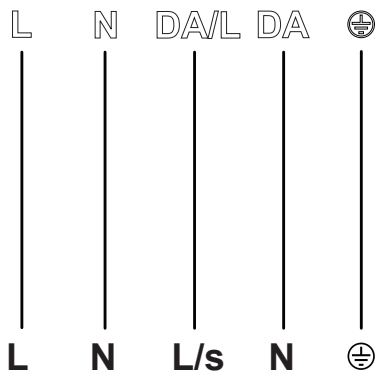
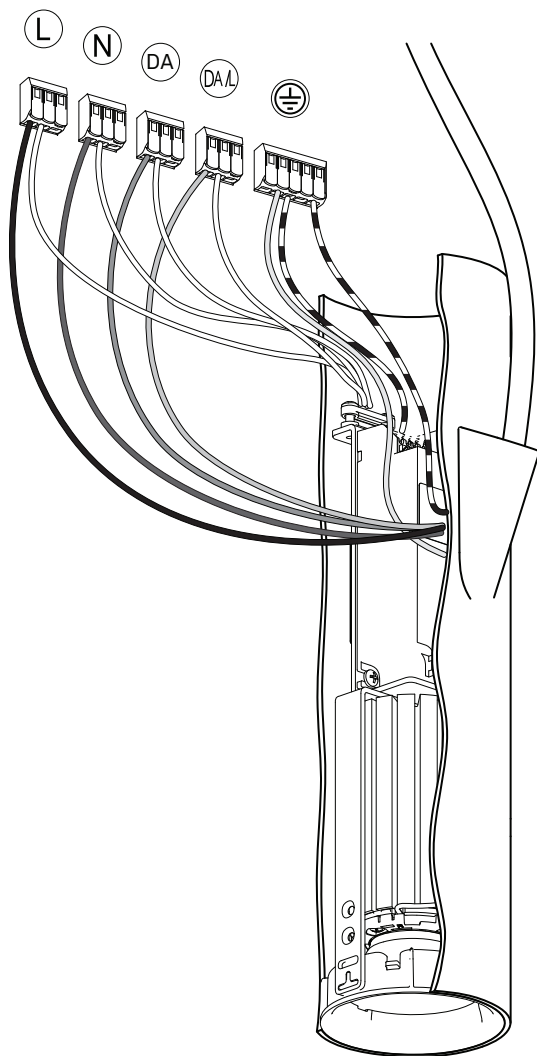

OFF

(0%)



MAX  
(100%)

ON

# E04270

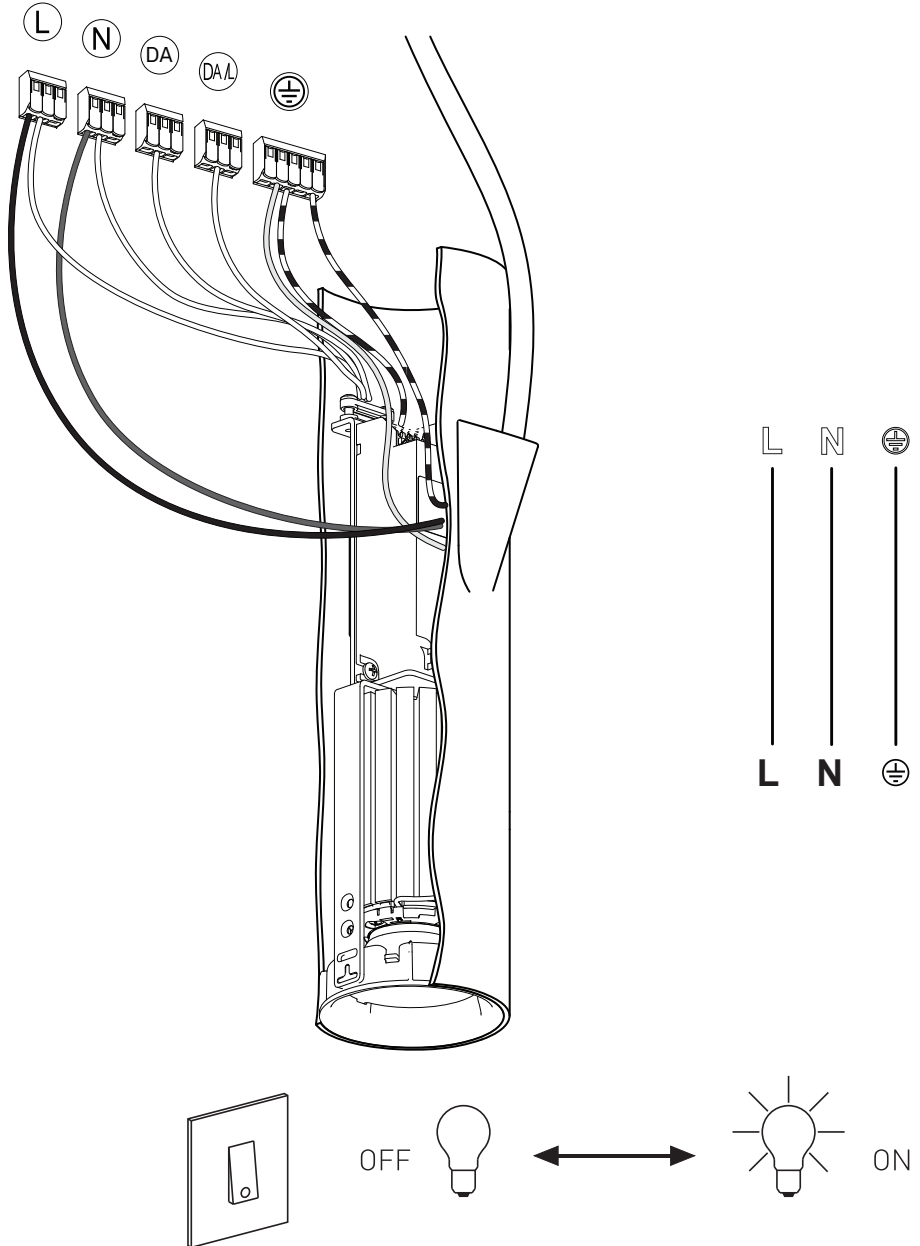

# 3

E04290

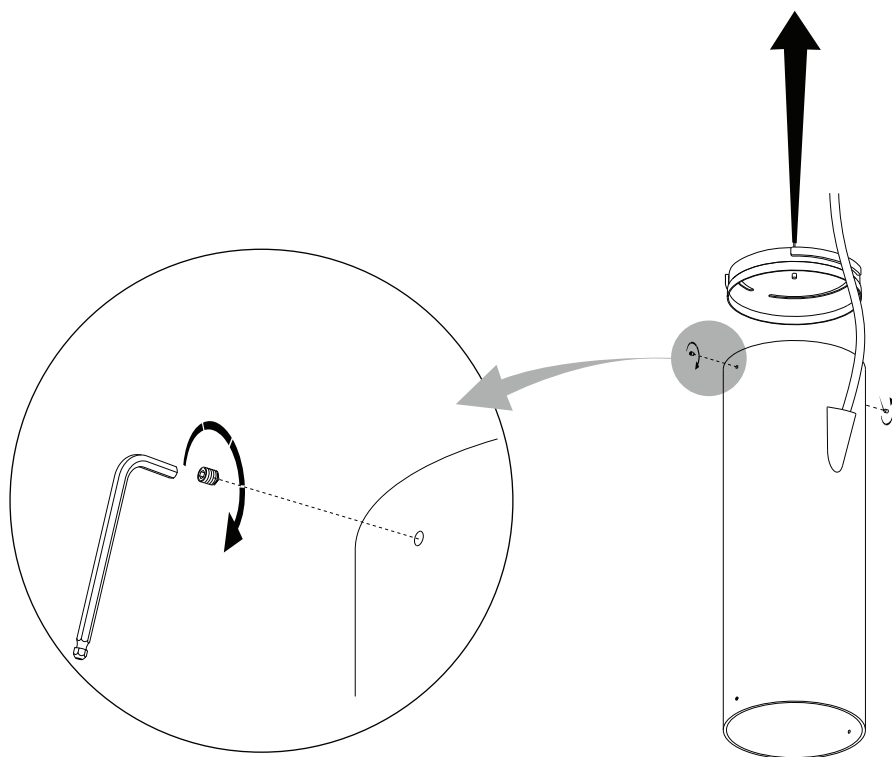

# 3.1 E04290

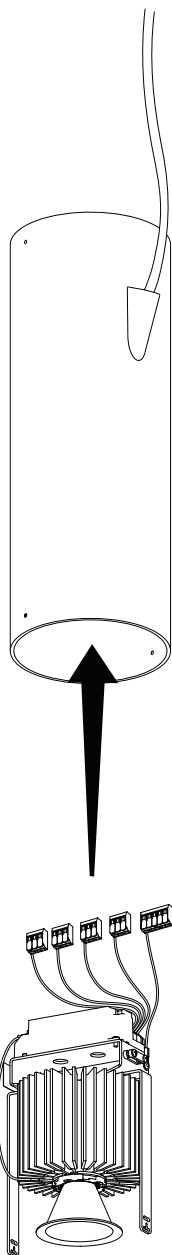

# 3.2 E04290

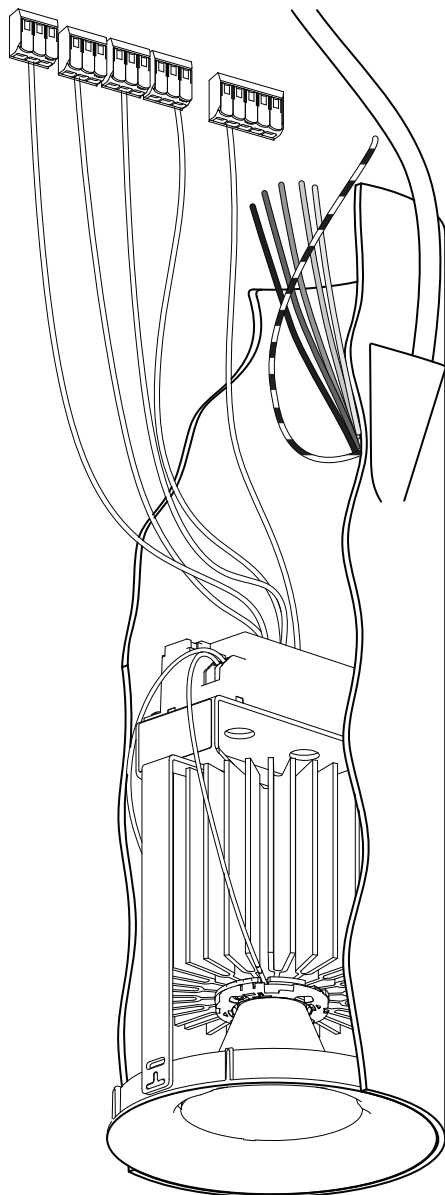

# 3.3 E04290

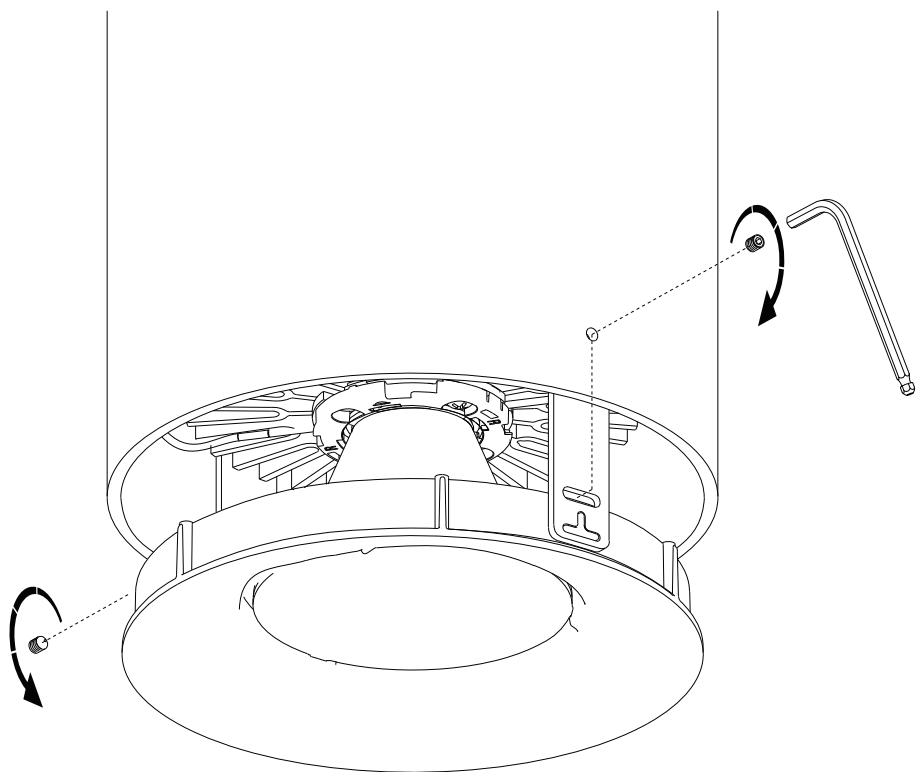



# 3.4 E04290

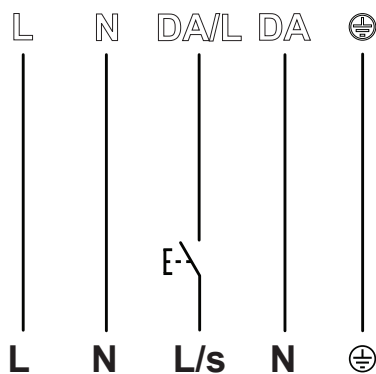
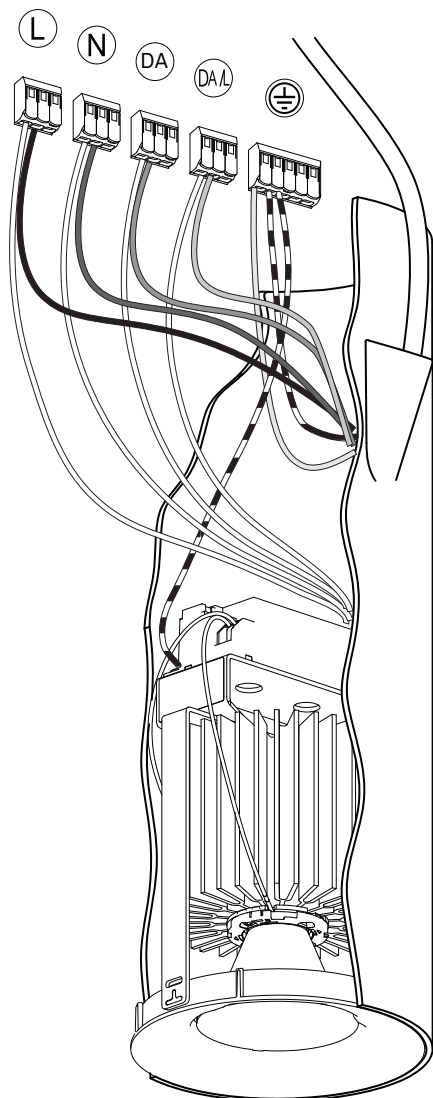

PUSH DIM



# E04290

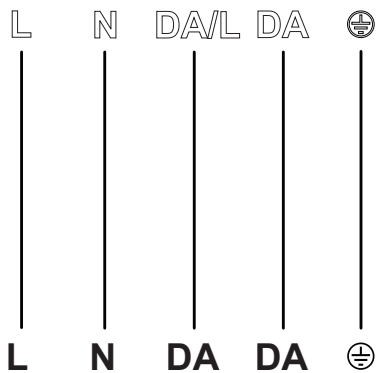
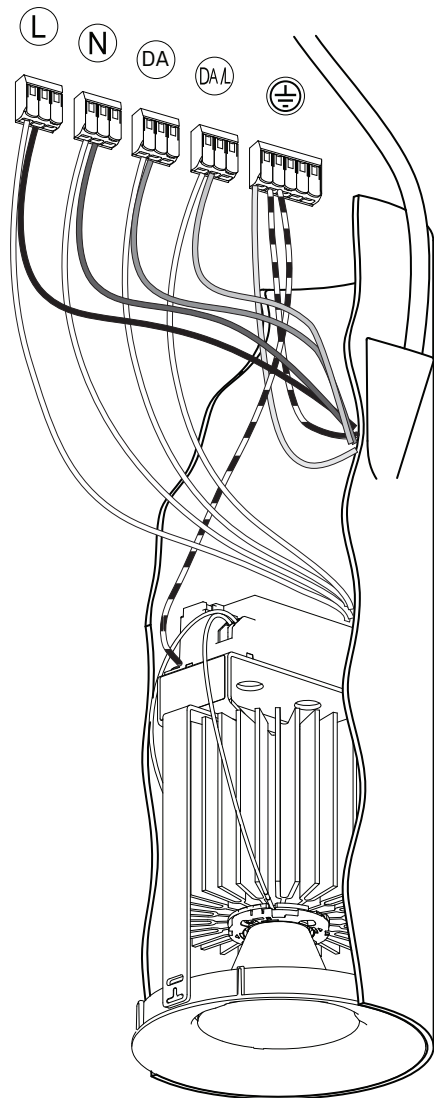

OFF

(0%)



MAX  
(100%)

ON

# E04290

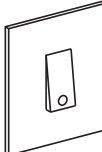
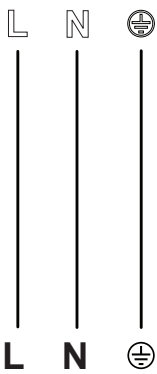
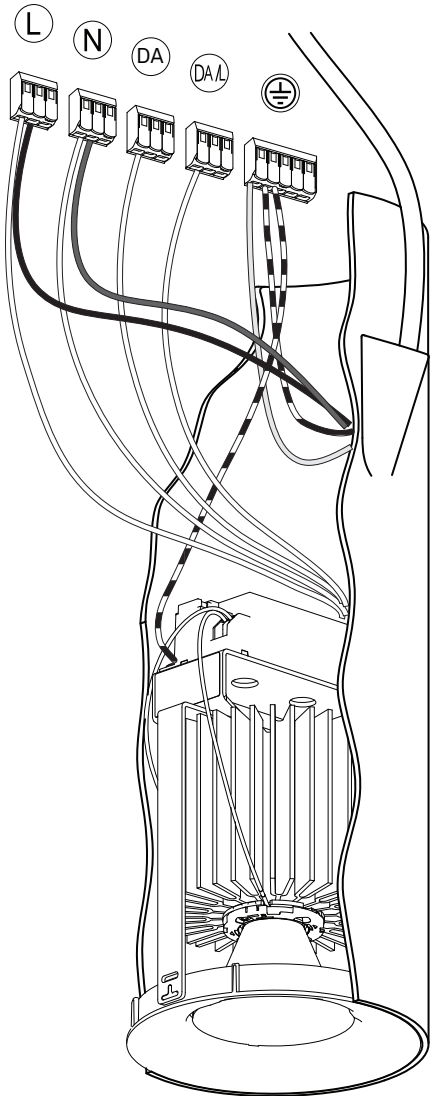

OFF



ON

# 4 E04280

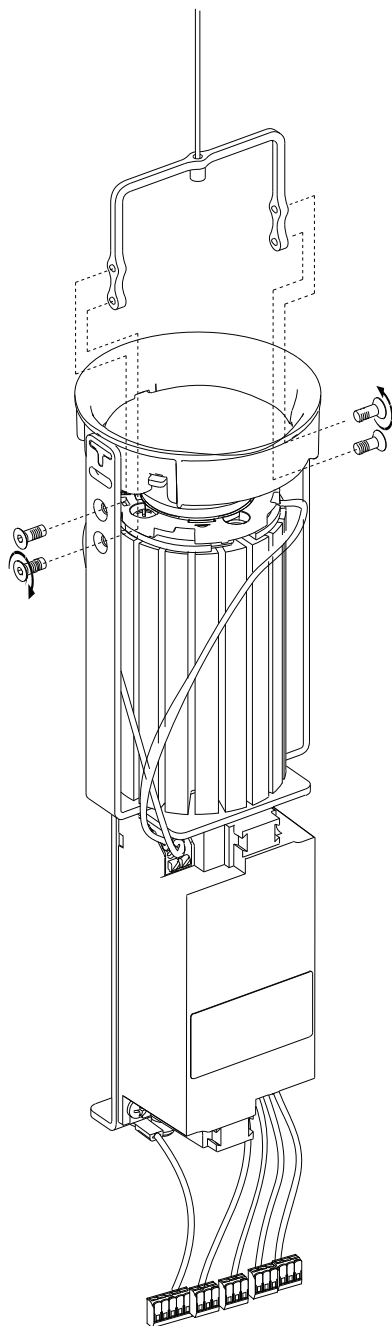

# 4.1 E04280

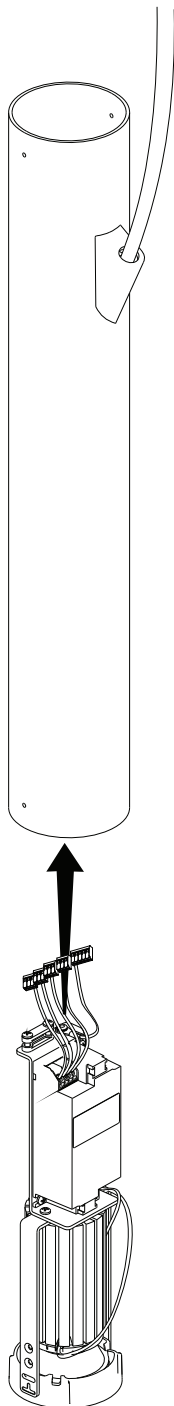

# 4.2 E04280

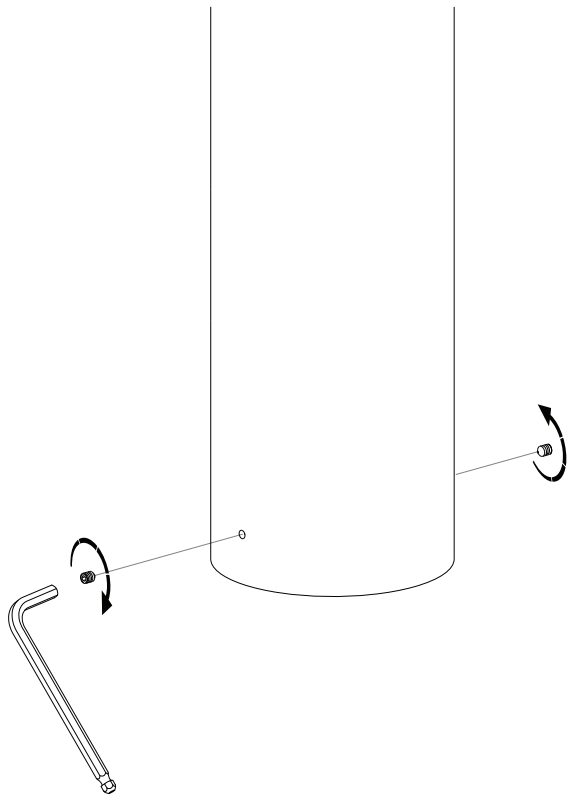

# 4.3 E04280

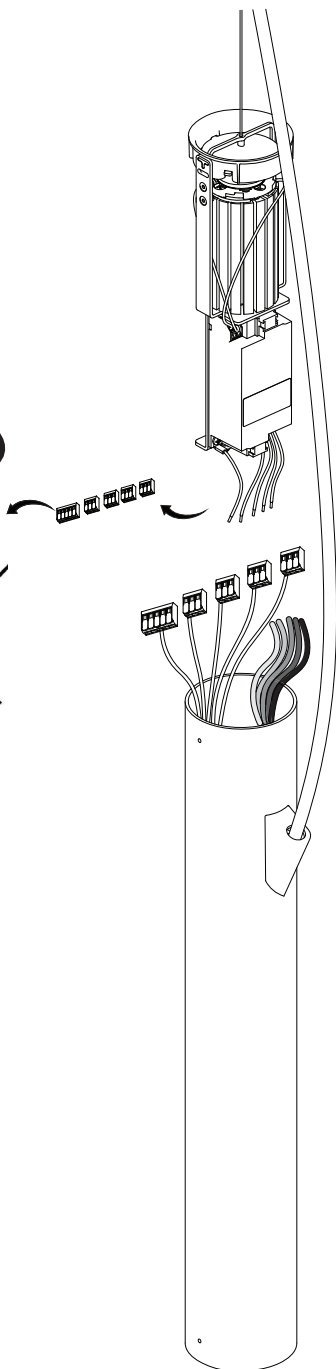

# 4.4 E04280

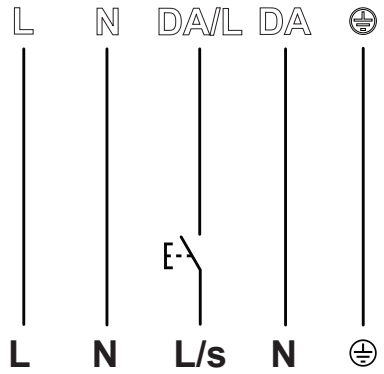
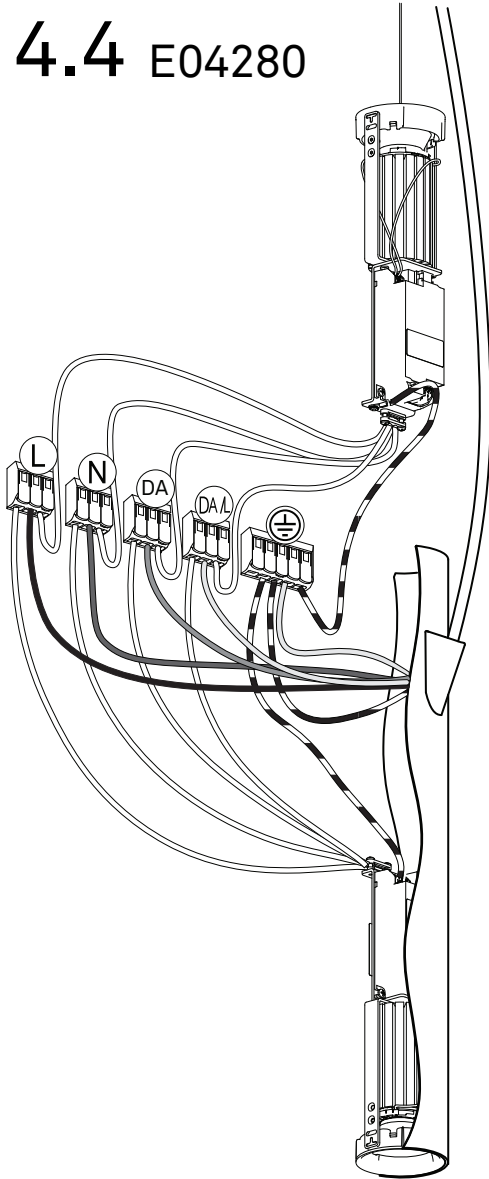

PUSH DIM





E04280

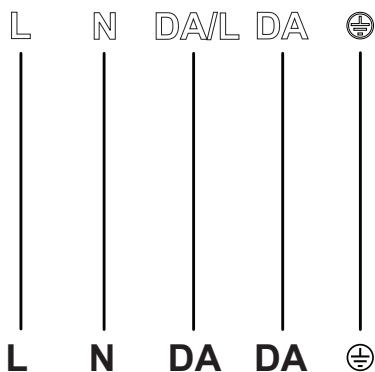
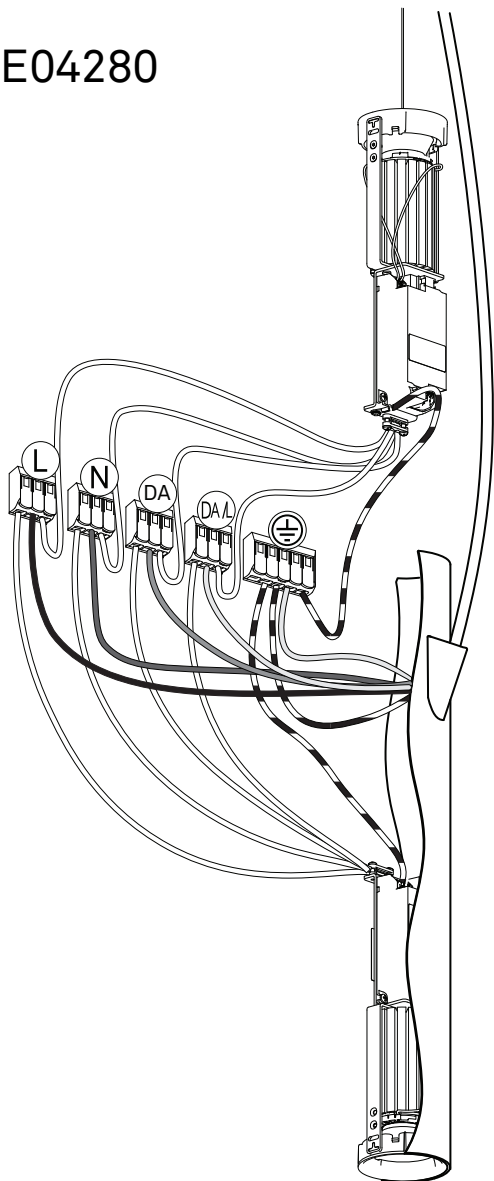

# E04280

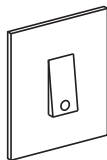
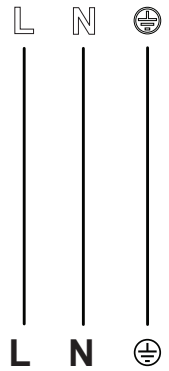
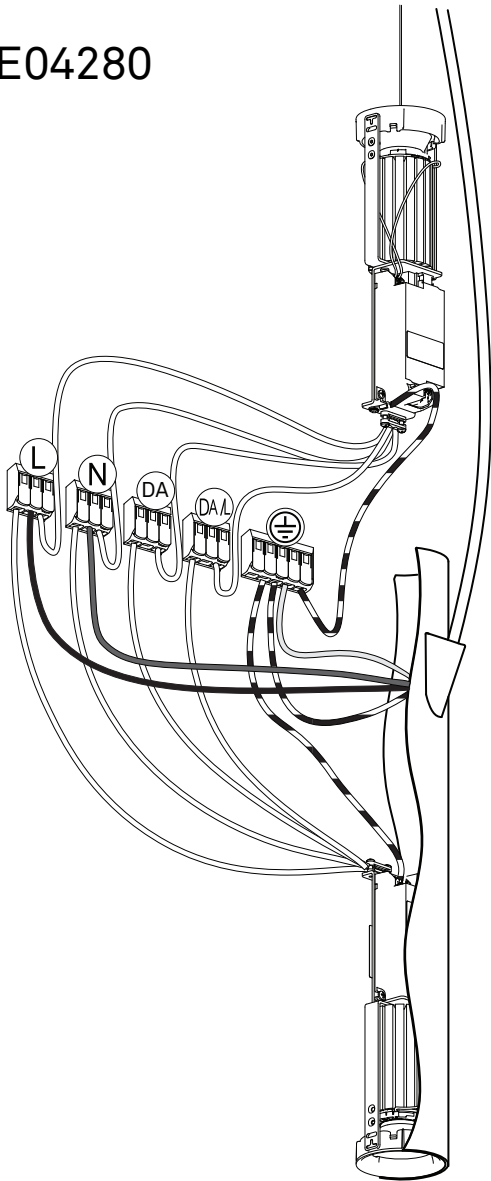

OFF



ON

5

E04270

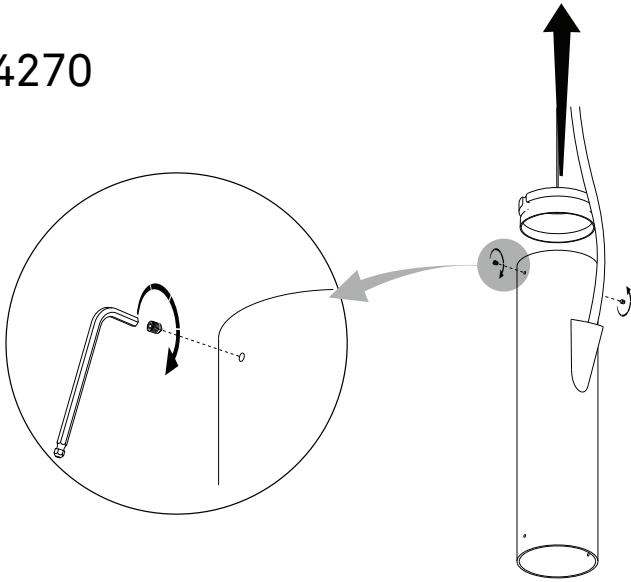

E041R

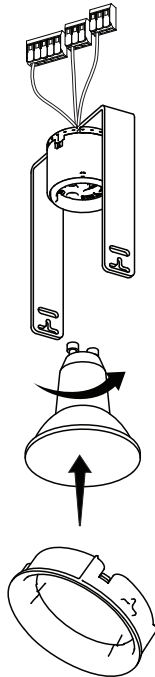

# 5.1 E04270

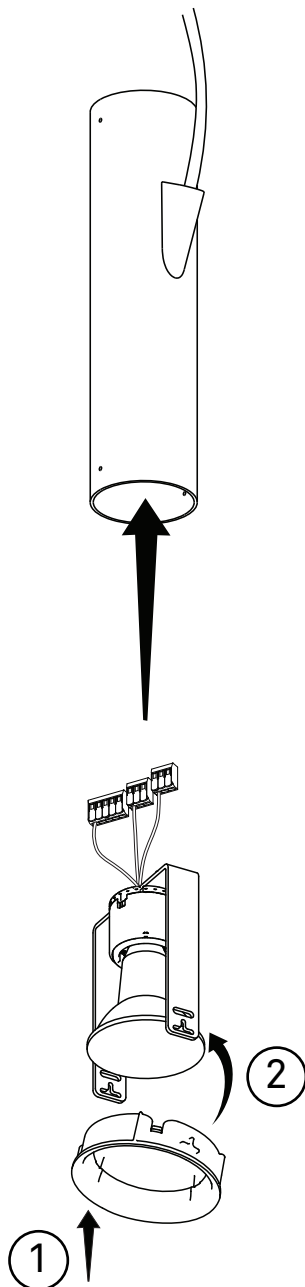

---

# 5.2 E04270

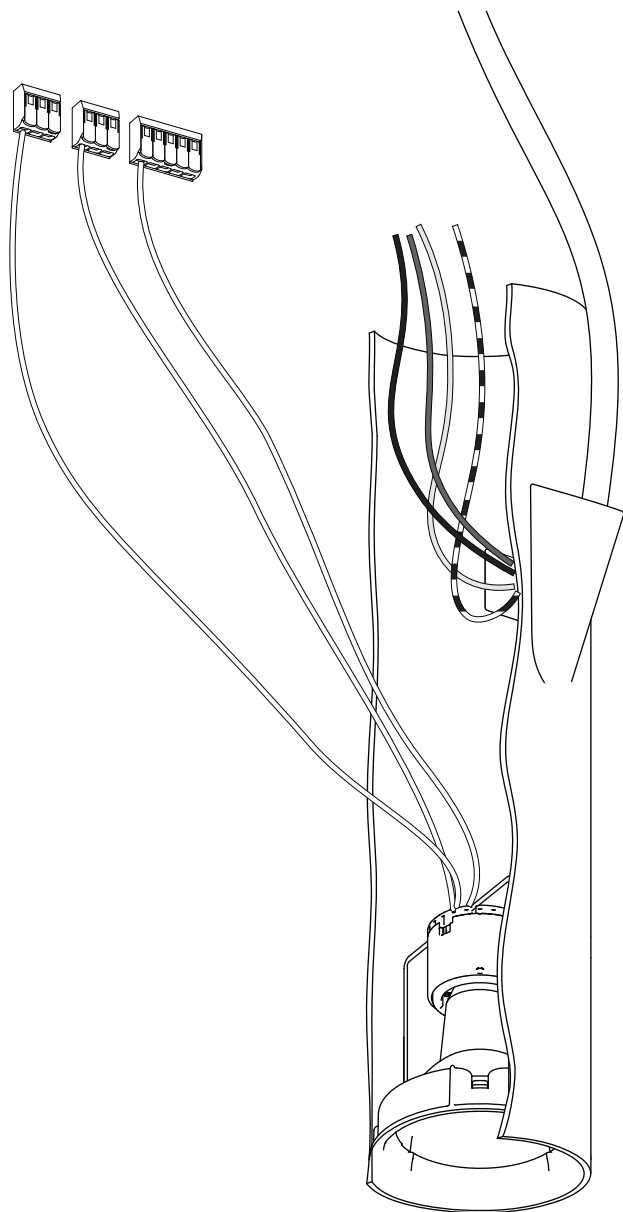

# 5.3 E04270

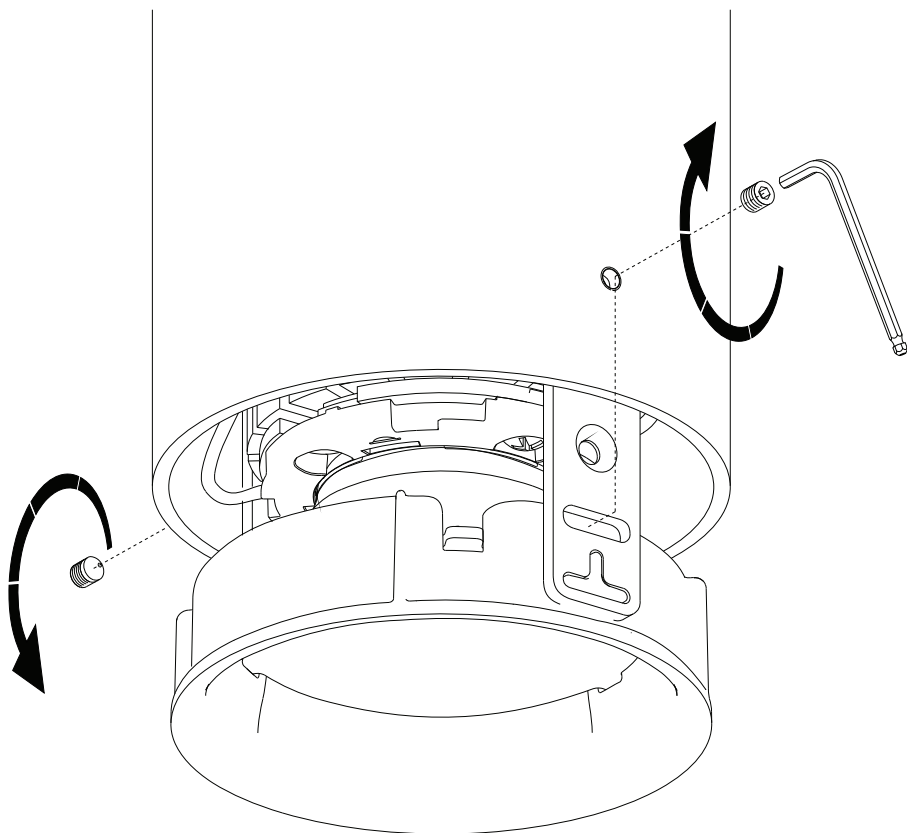

# 5.4 E04270

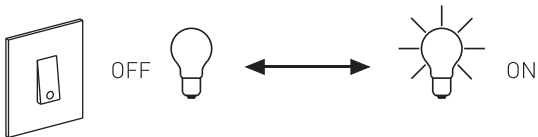
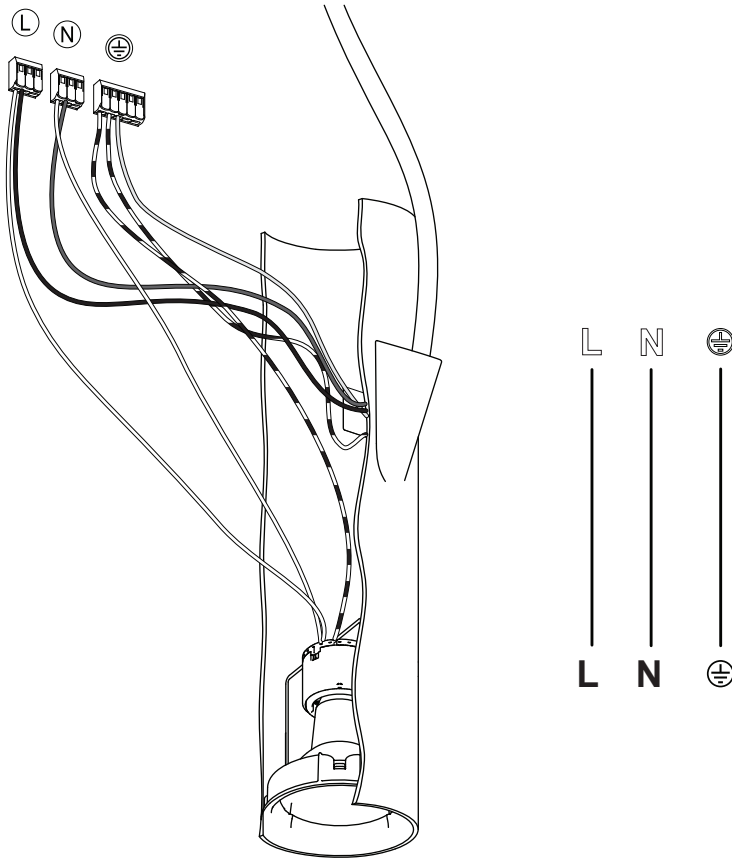

## PHASE CUT DIM



# 6

E04280

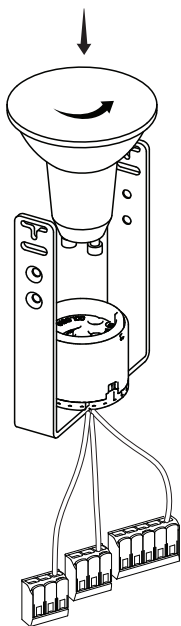

2X

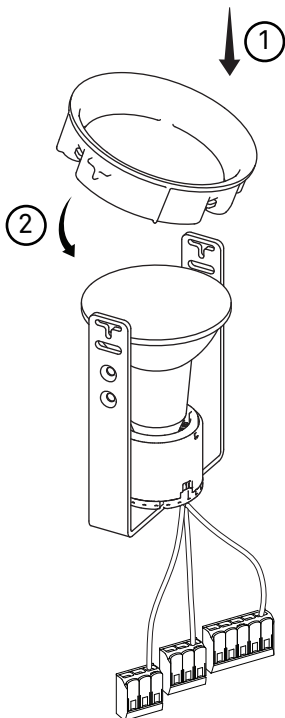

2X



# 6.1 E04280

1X

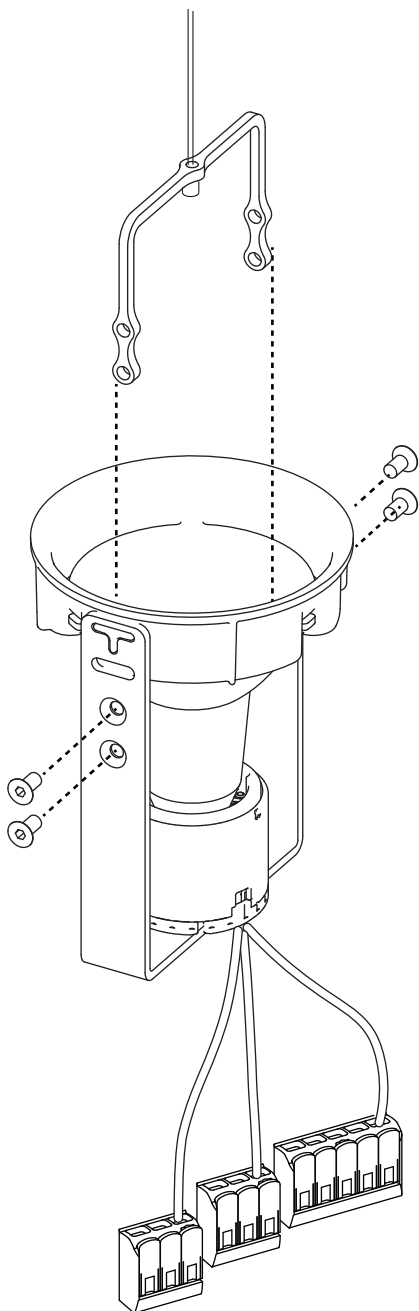

# 6.2 E04280

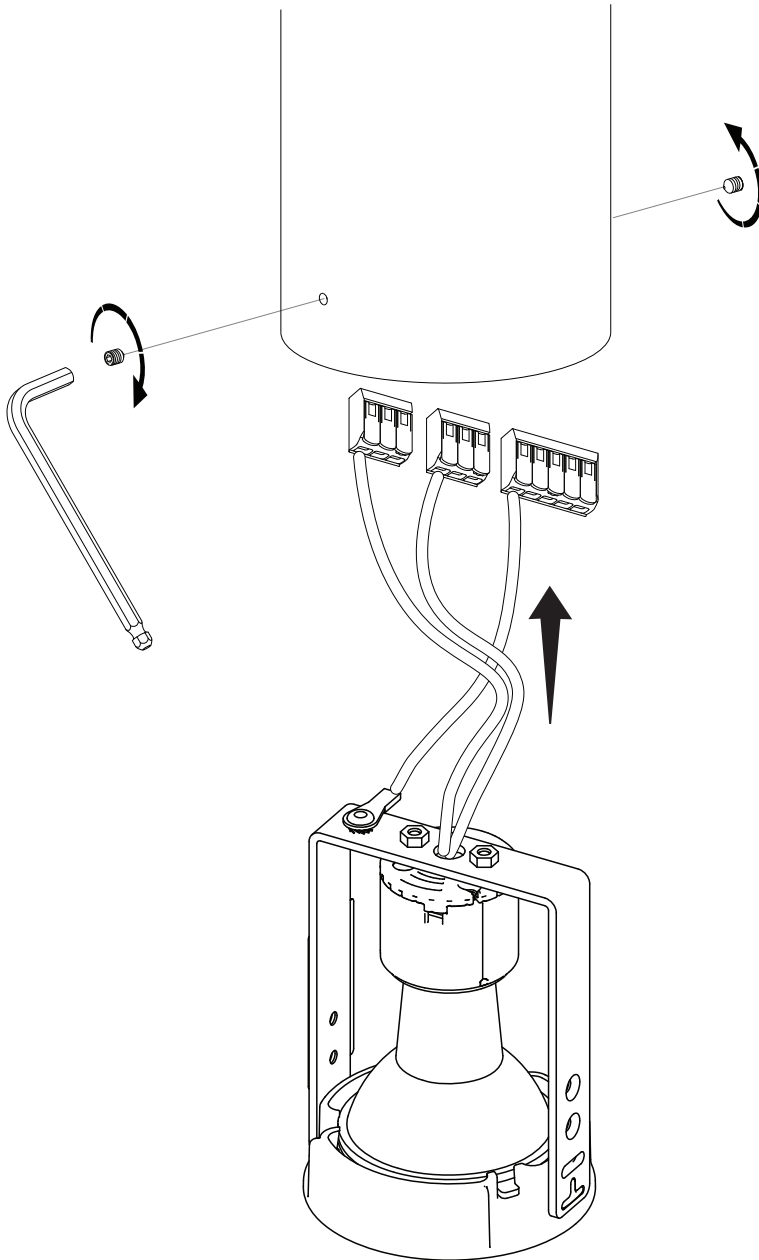

# 6.3 E04280

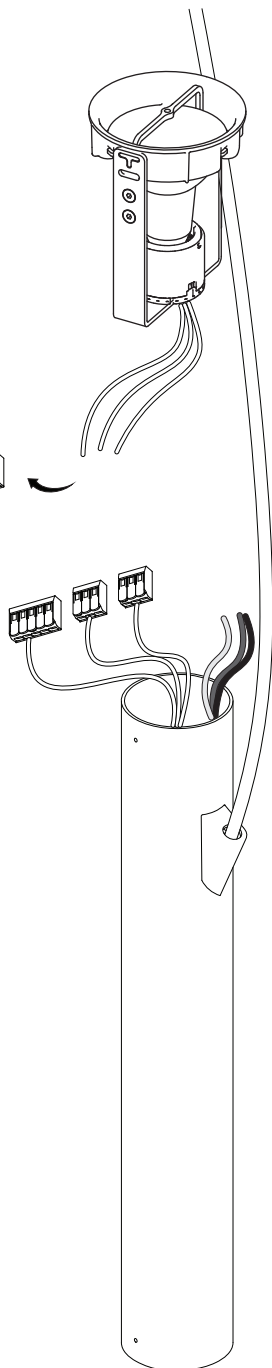
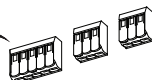

# 6.4 E04280

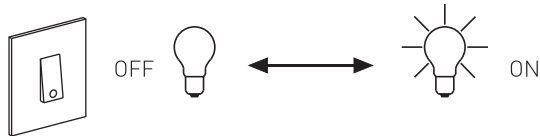
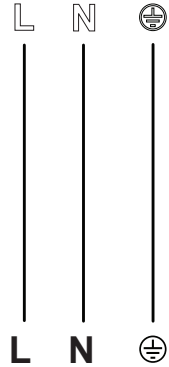
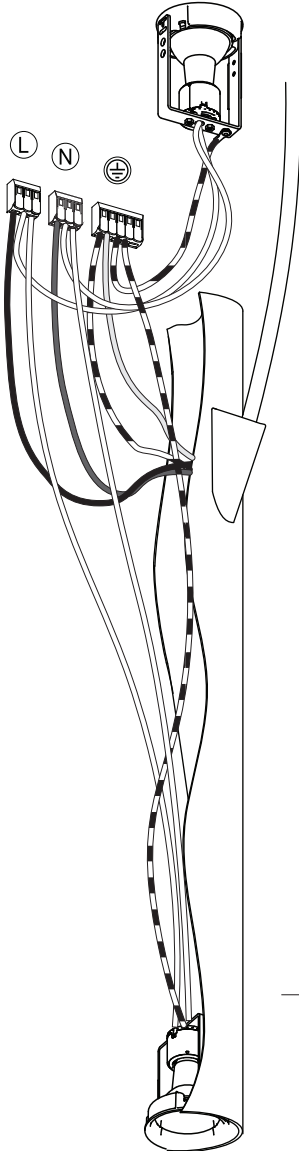

## PHASE CUT DIM



# 7 E04290

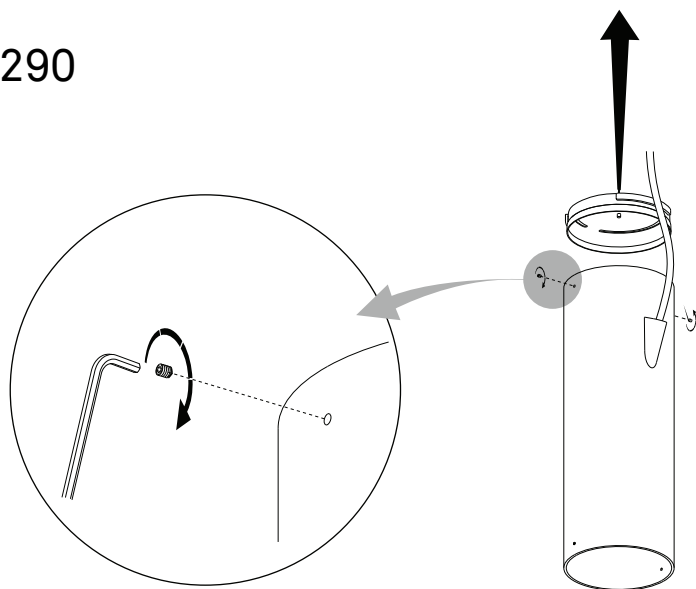

# E042R

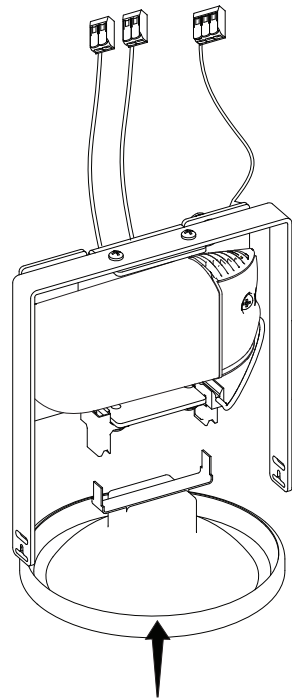

# 7.1 E04290

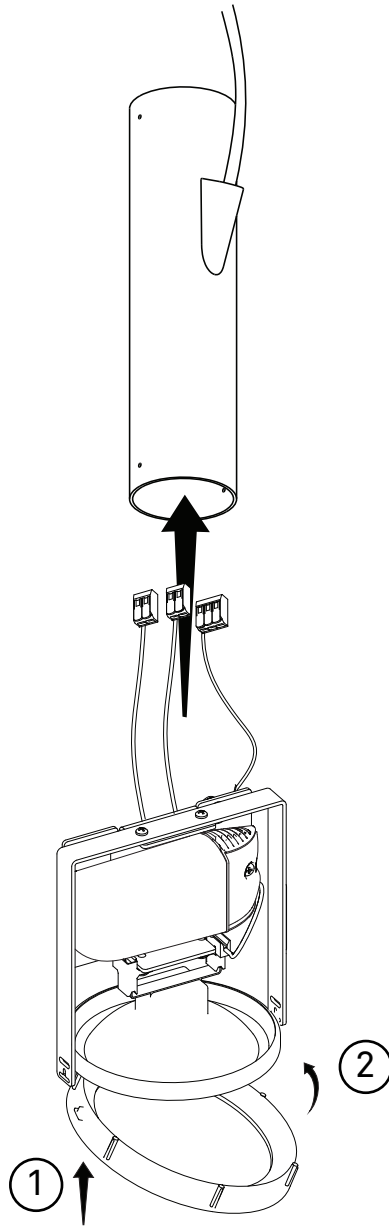

---

# 7.2 E04290

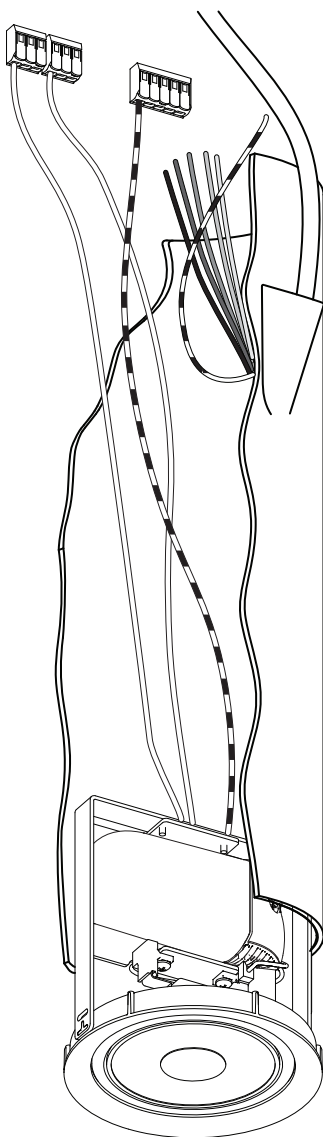

# 7.3 E04290

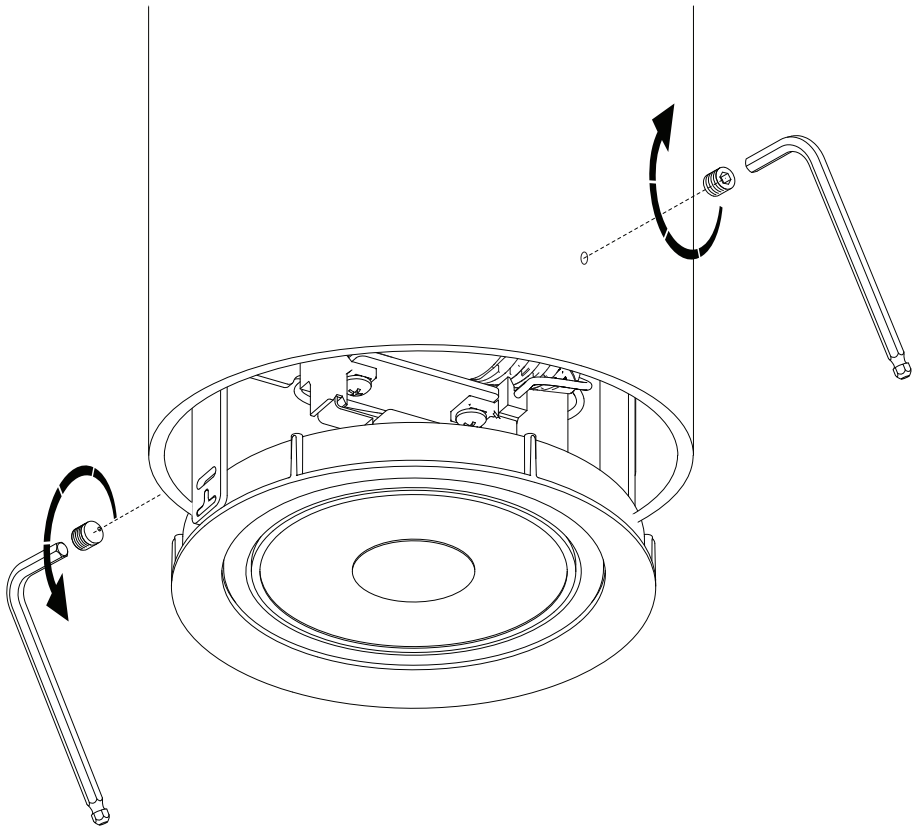



# 7.4 E04290

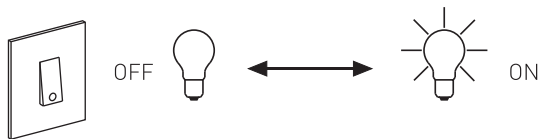
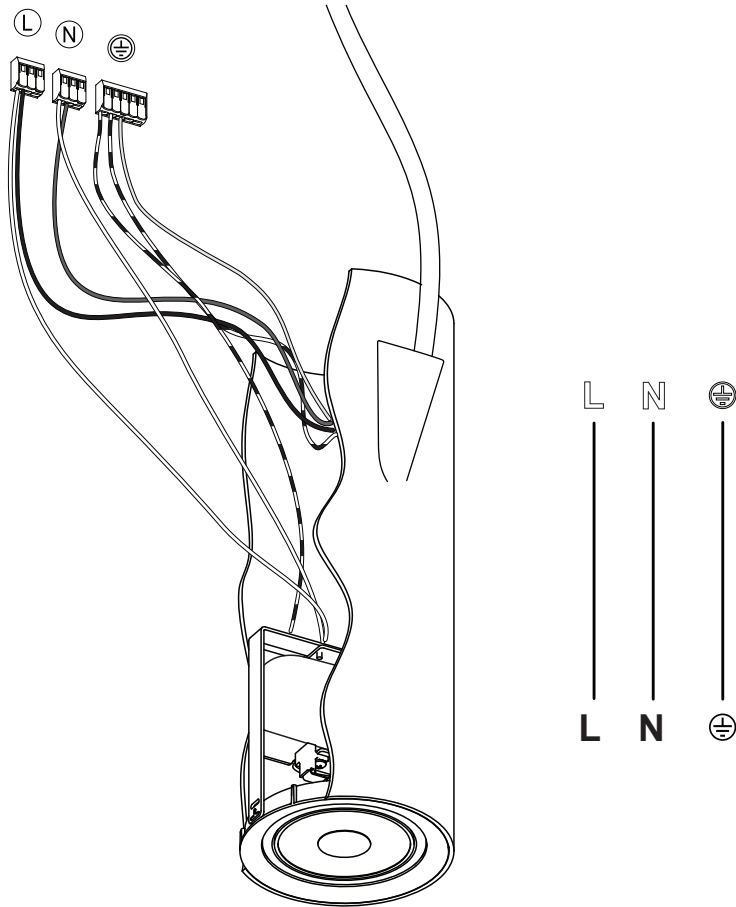

## PHASE CUT DIM



# 8

E04270 - E047290

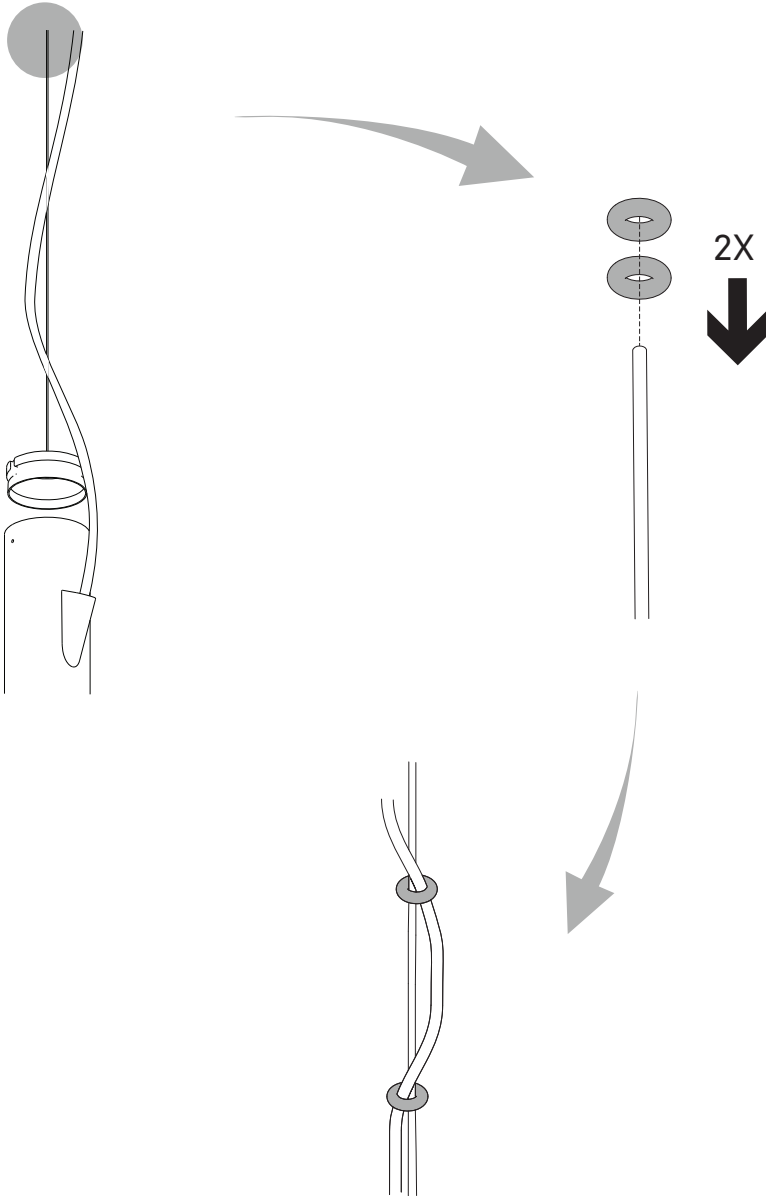

# 8.1 E04280

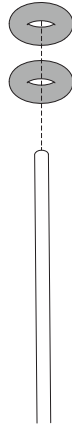
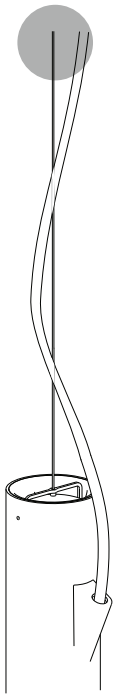

2X



# 8.2 E04270 - E04290

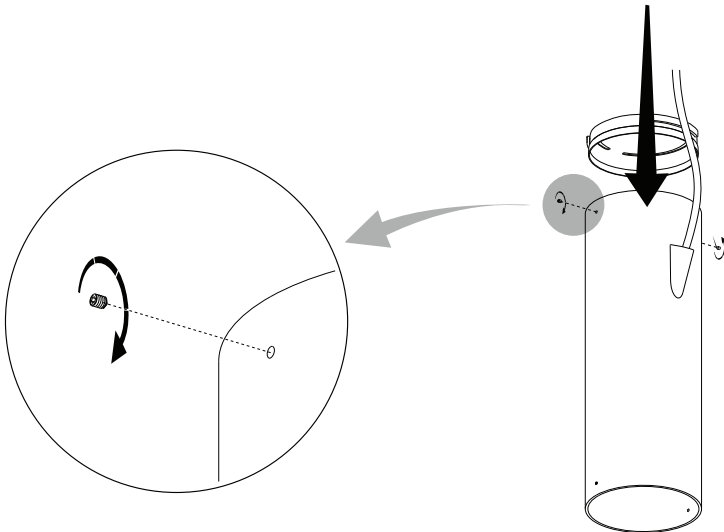
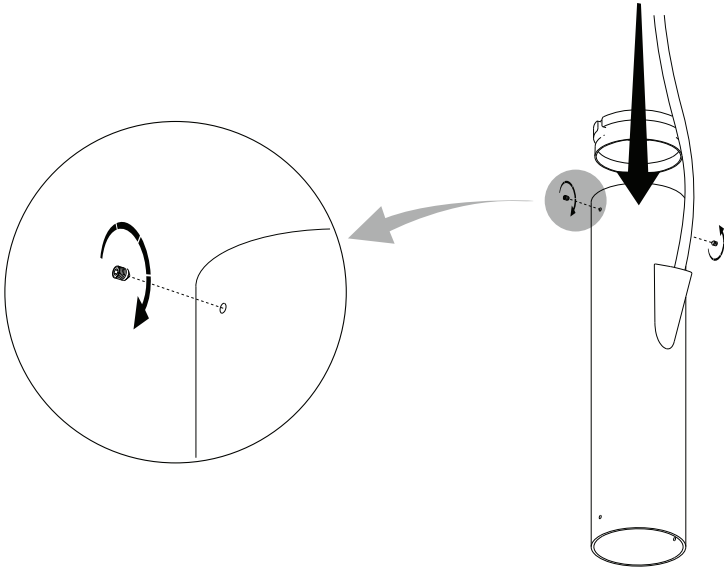

# 8.3 E04280

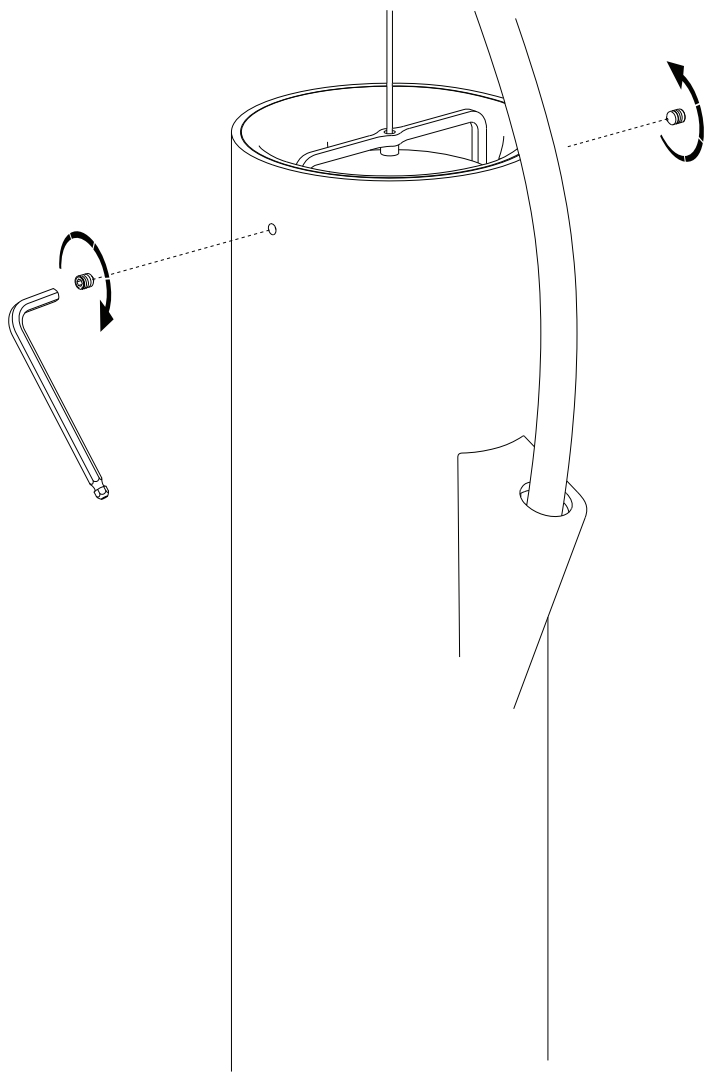

# 8.4 E04270 - E04280 - E04290

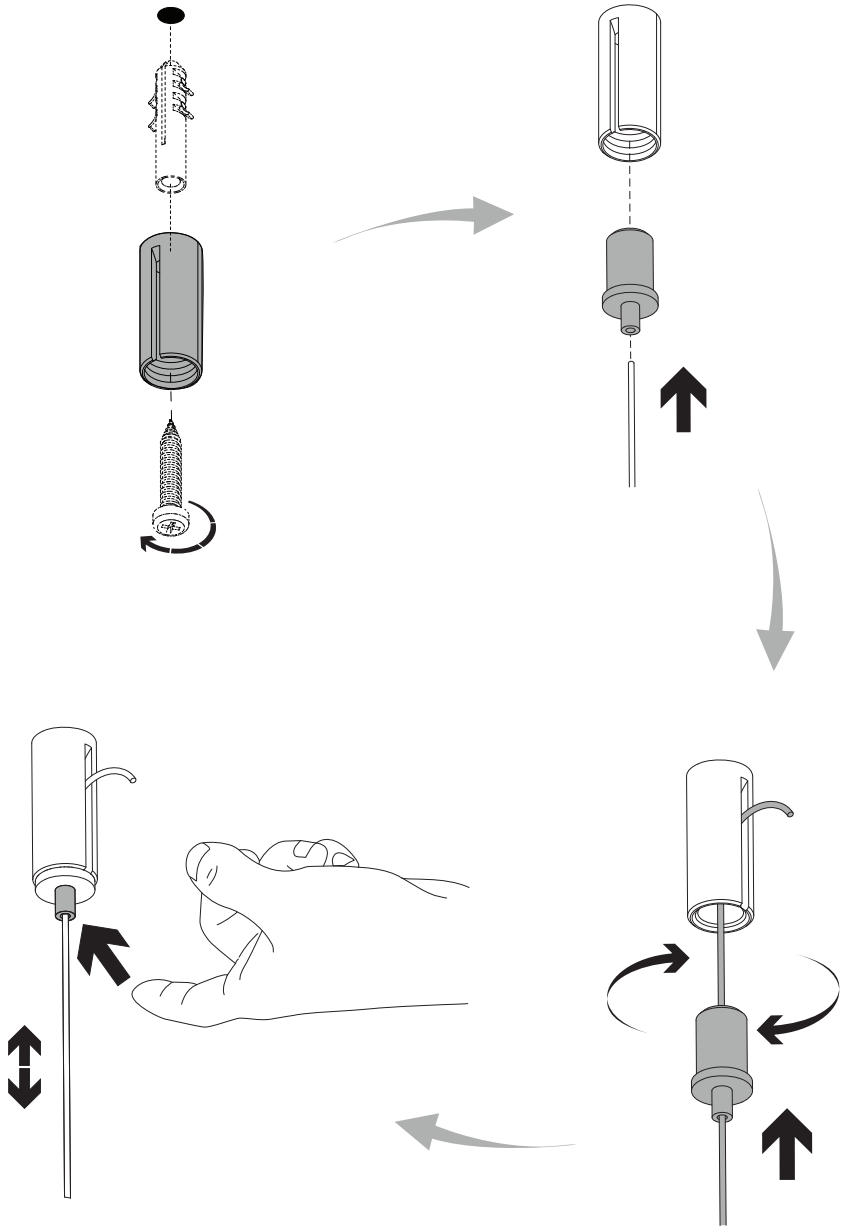

---

# 8.5 E04270 - E04280 - E04290

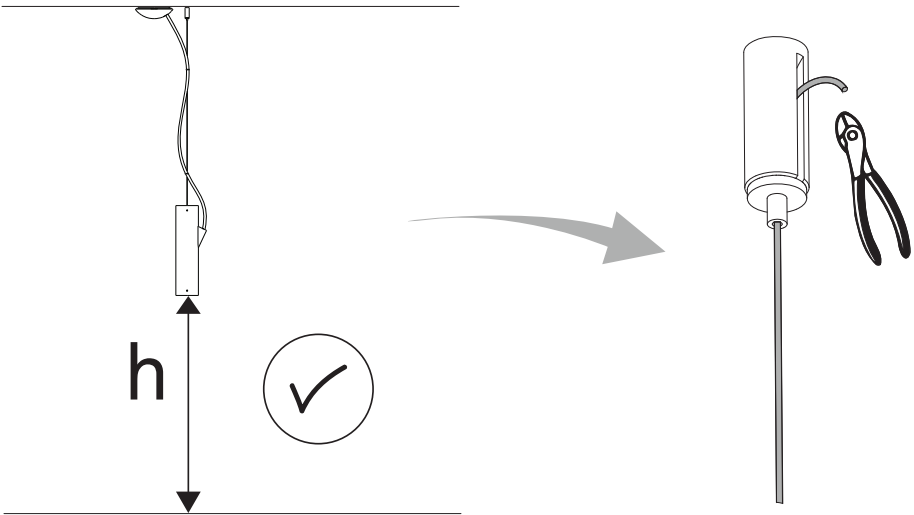

# 9 E042M-E042W-E044M-E044W E041M-E041W-E043M-E043W

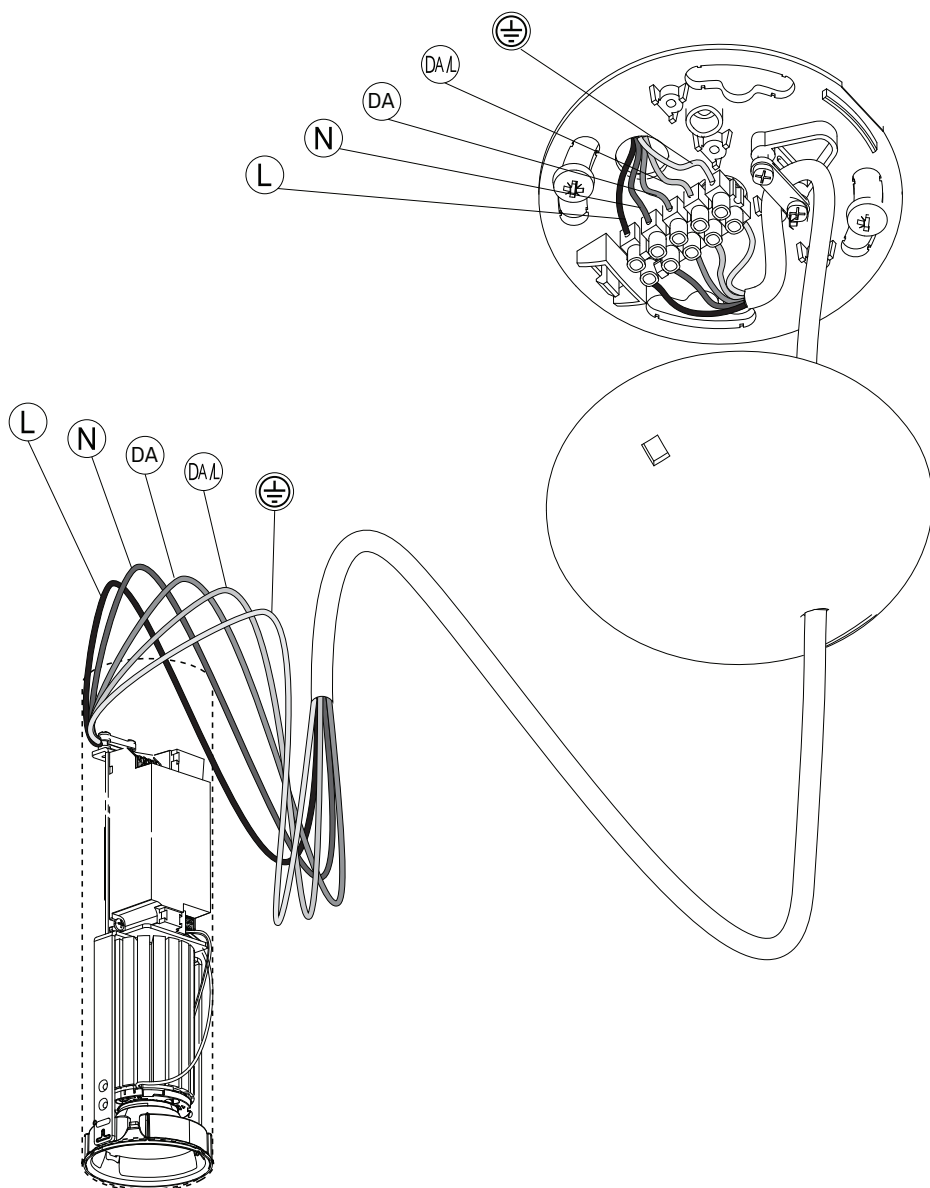



# 9

## E041R - E042R

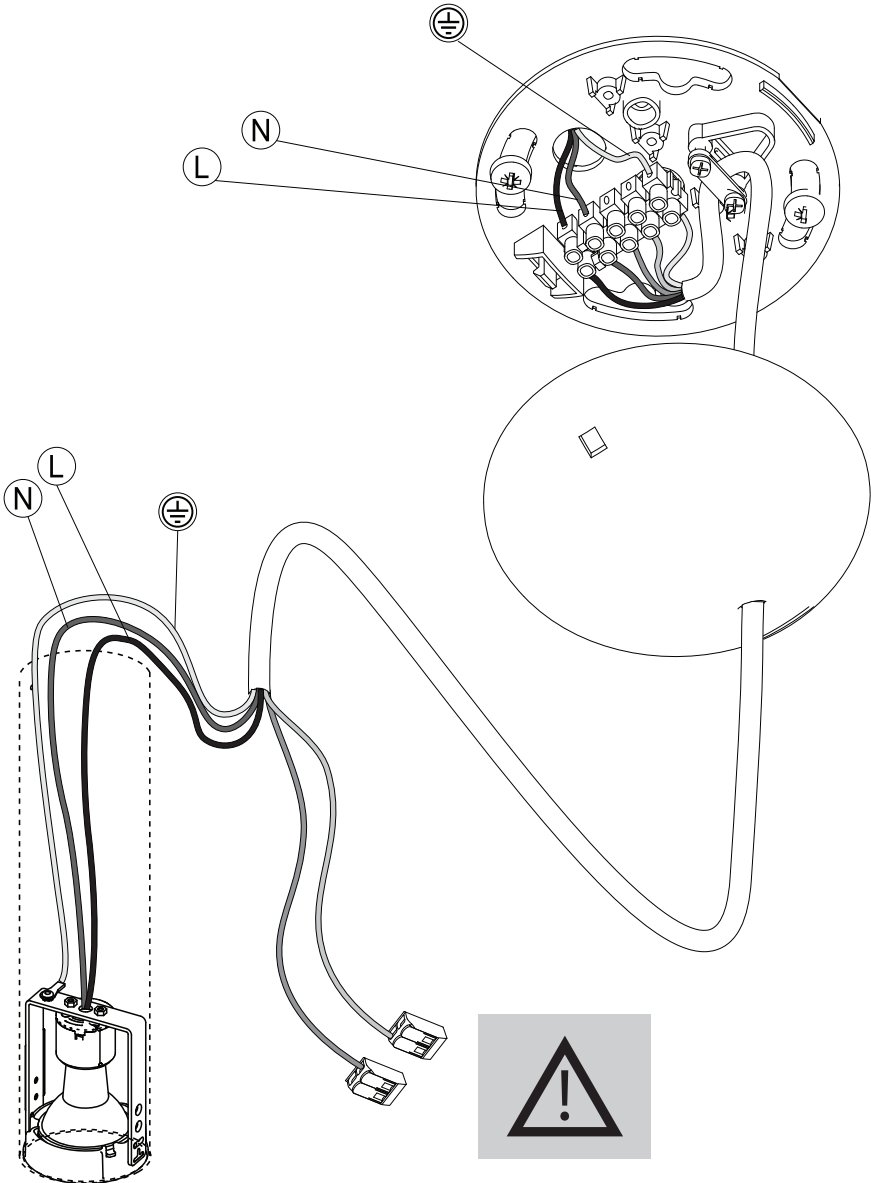

# 10

## E04270 - E04280 - E04290

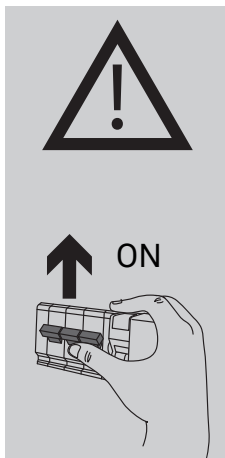
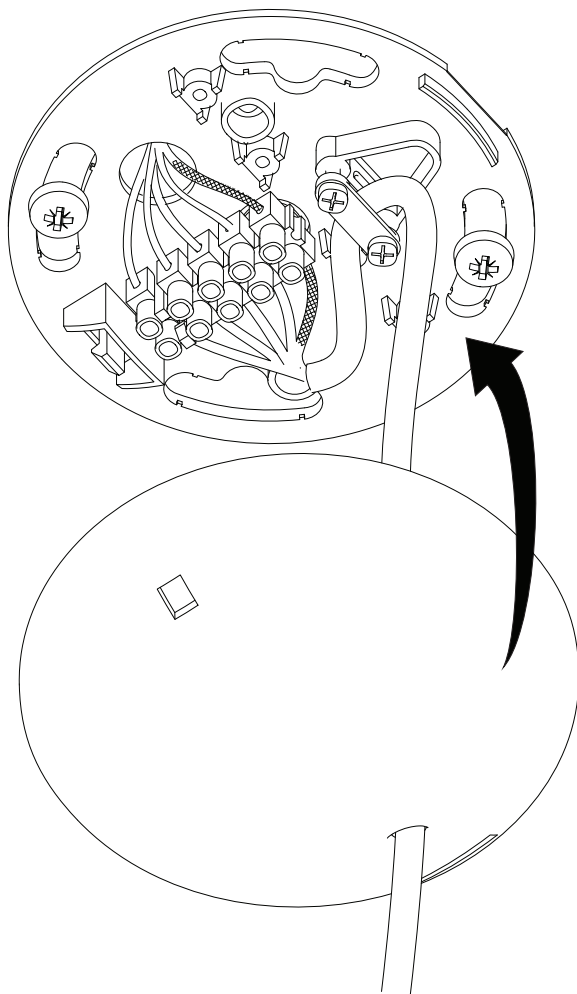

# 11

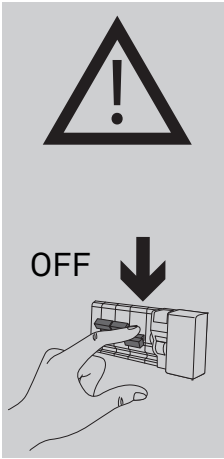

11.1

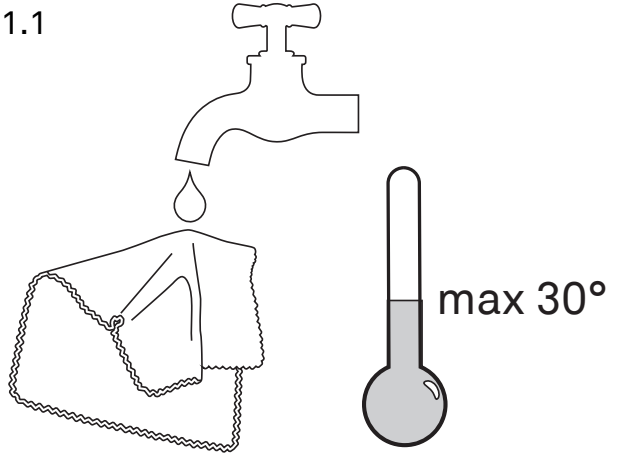

11.2

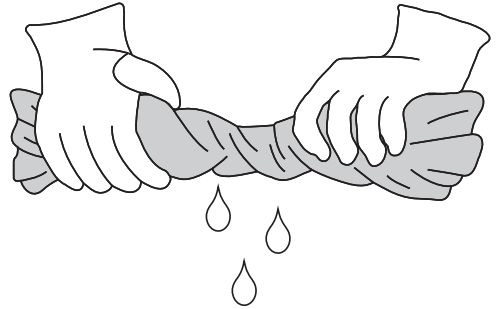

11.3

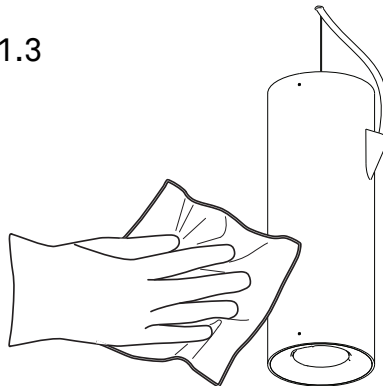



[www.luceplan.com](http://www.luceplan.com)

E0401A32