

# TITANIA

design Alberto Meda / Paolo Rizzatto

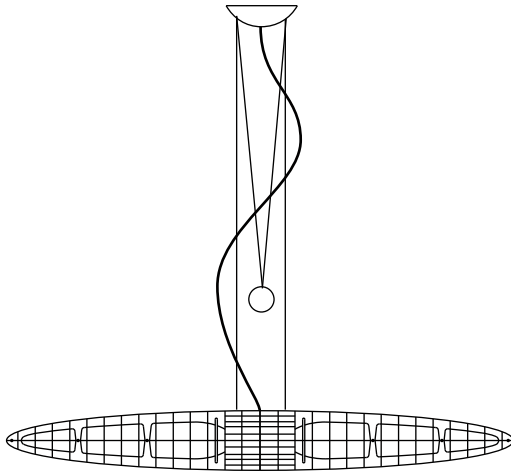

**LUCE  
PLAN**

D17



# TITANIA

design Alberto Meda / Paolo Rizzato

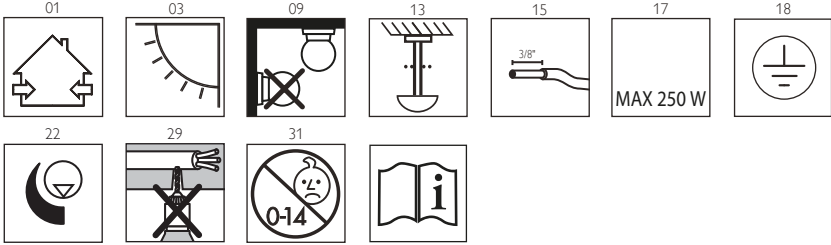

# D17

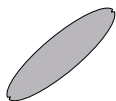
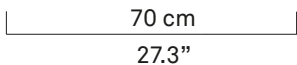
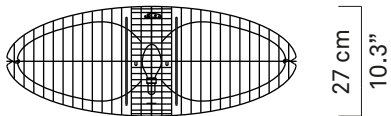
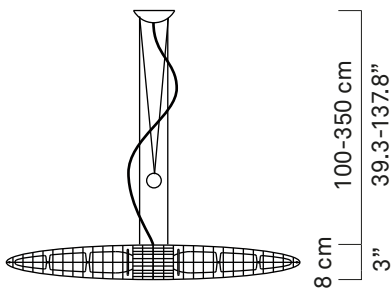

x10

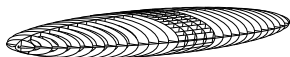

x1



x1



x1



x2



x1



x1



x1



x1



x1



a



b

**kg** 1,3 kg

**lb** 2.9 lb



250W T-10  
halogen/frosted  
shielded  
med. base



# TITANIA

design Alberto Meda / Paolo Rizzatto

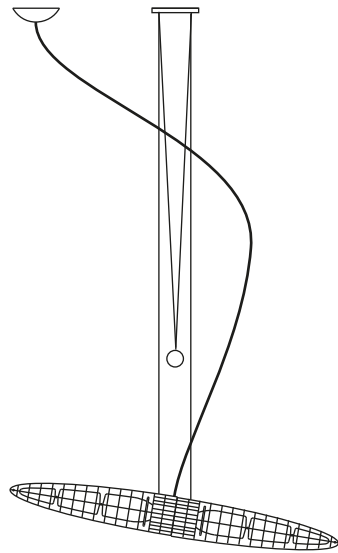
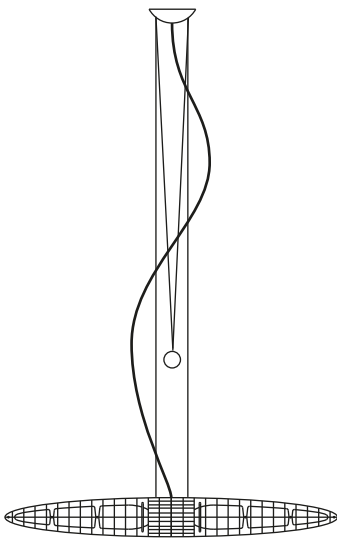

1

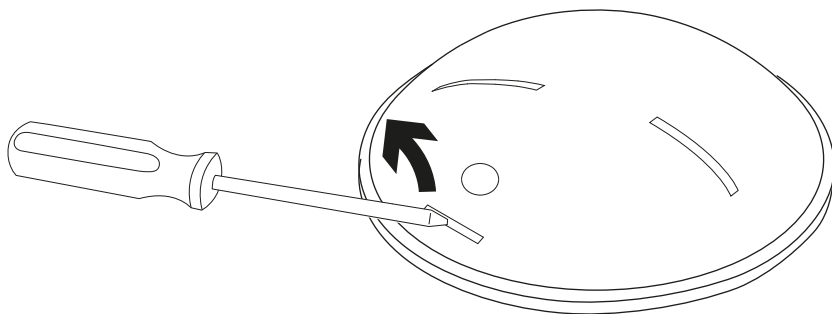

# 1.1

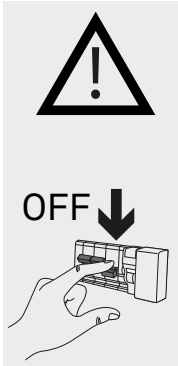

L  
black  
noir  
negro

⊕ yellow/green  
jaune/vert  
amarillo/verde

N  
white  
blanc  
blanco

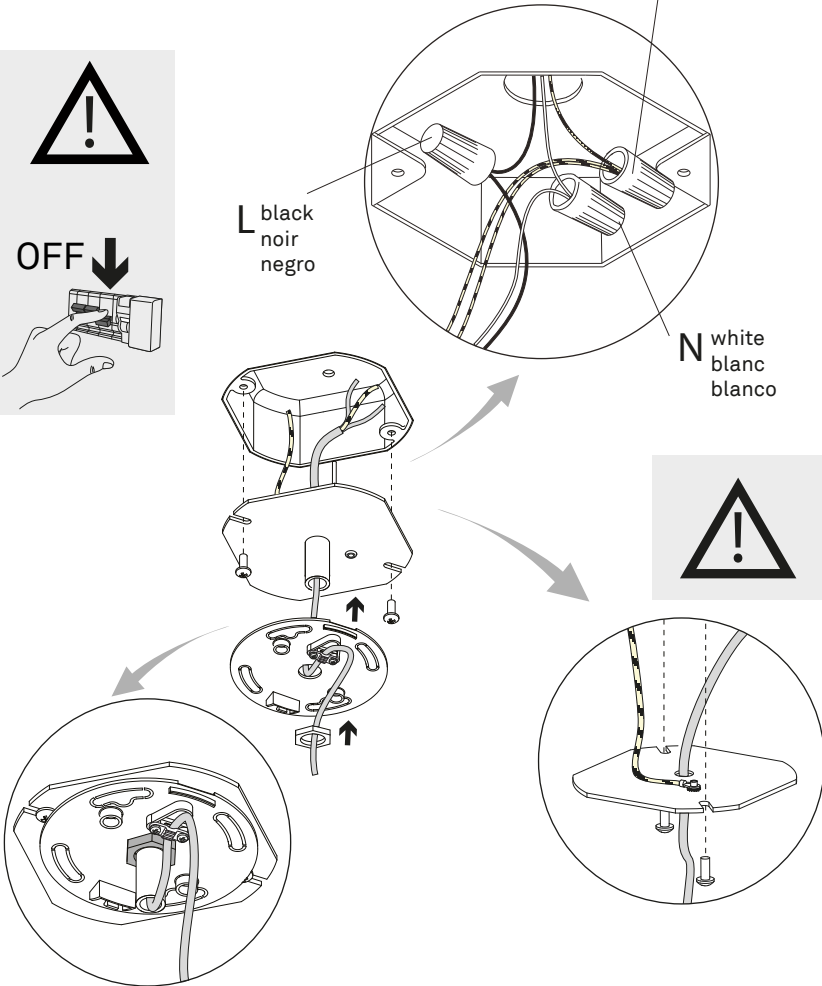

# 2

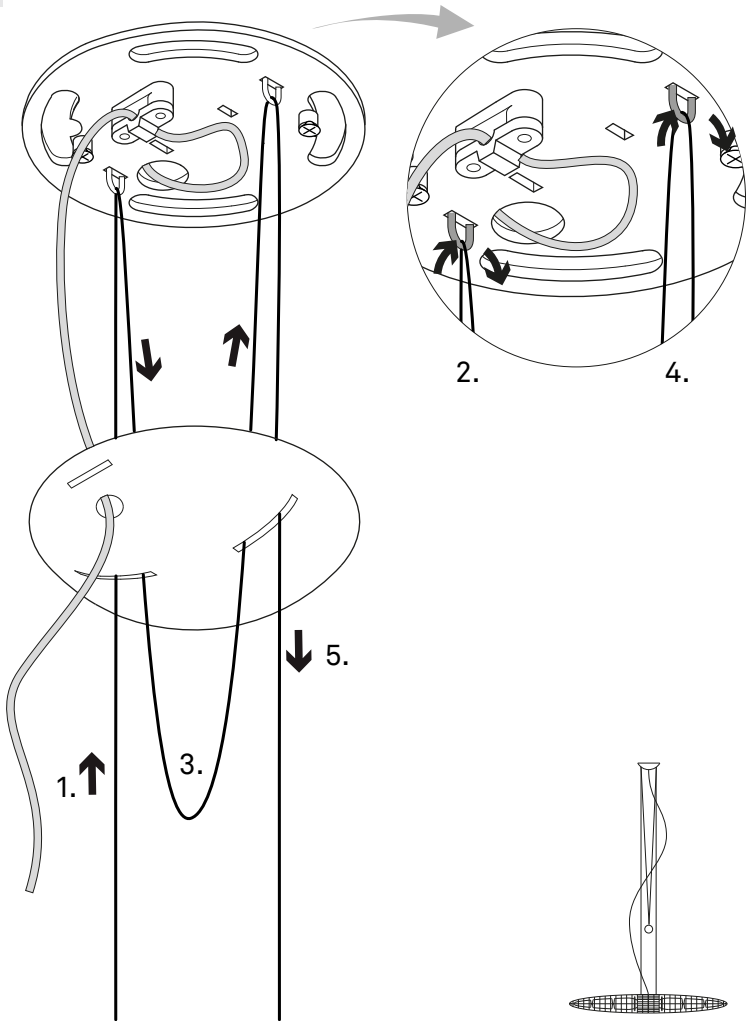

# 2.1

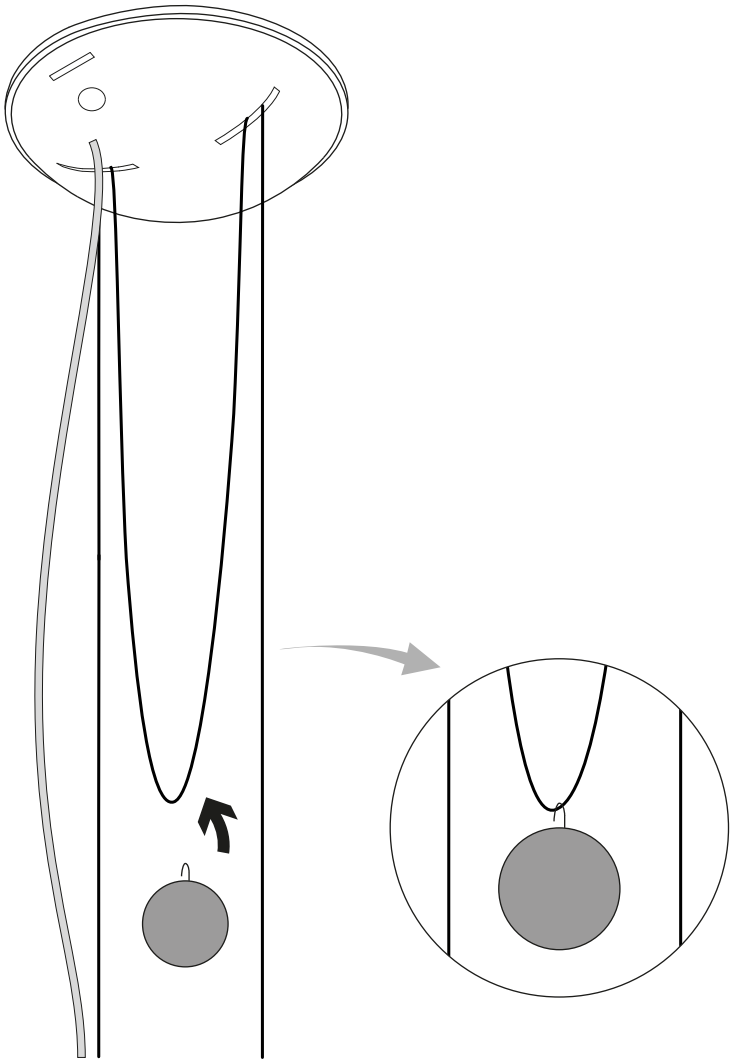



2

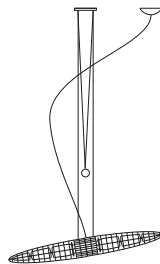
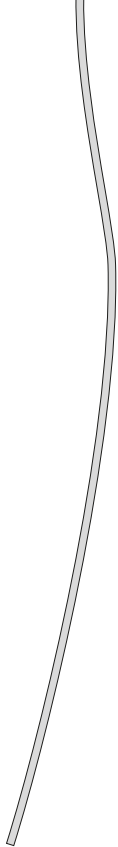
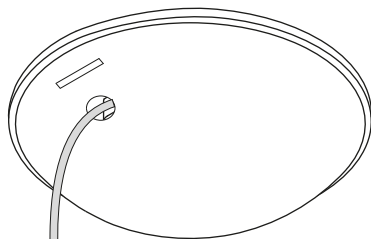
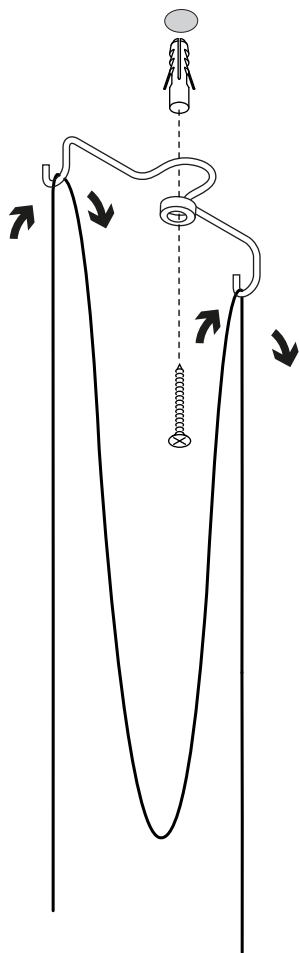



# 2.1

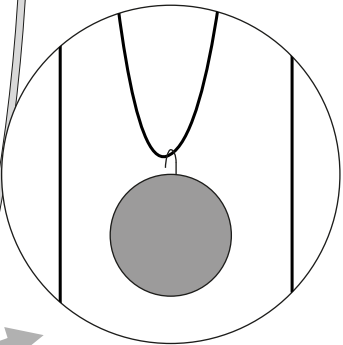
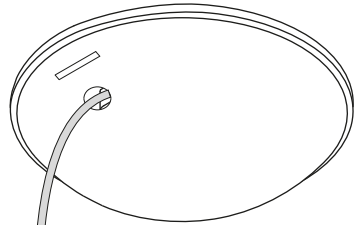
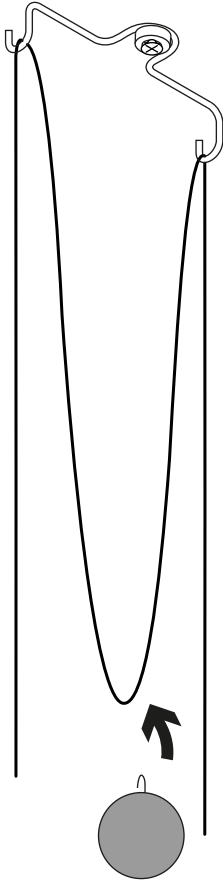

3 x2

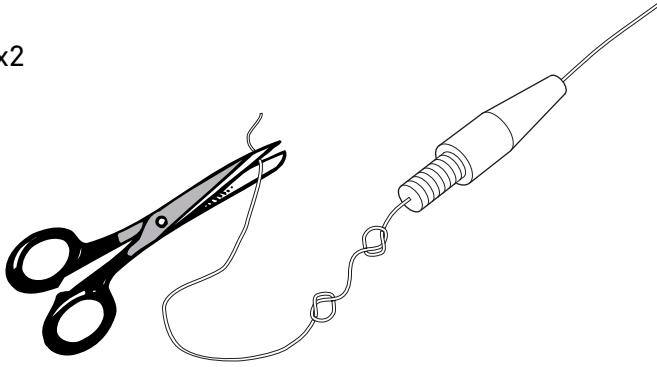

3.1

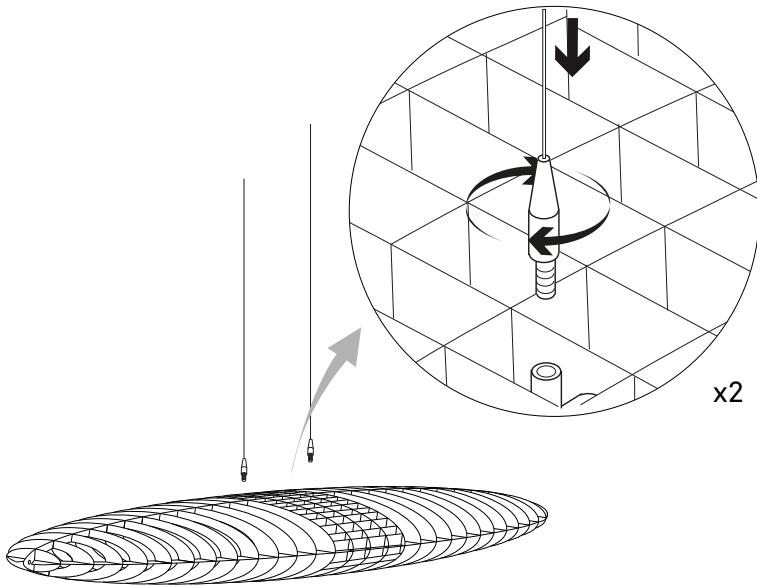



## 3.2

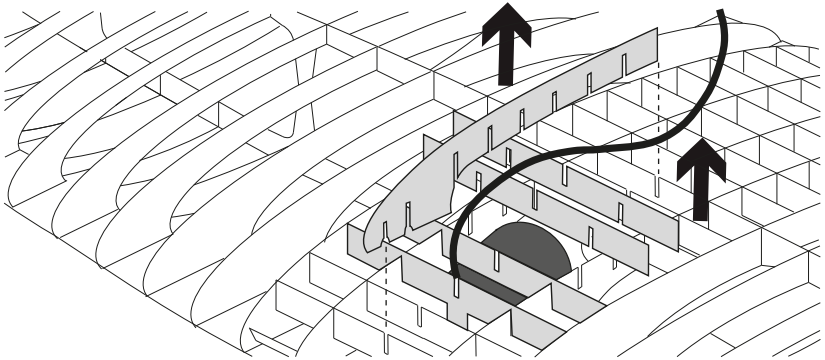

## 3.3

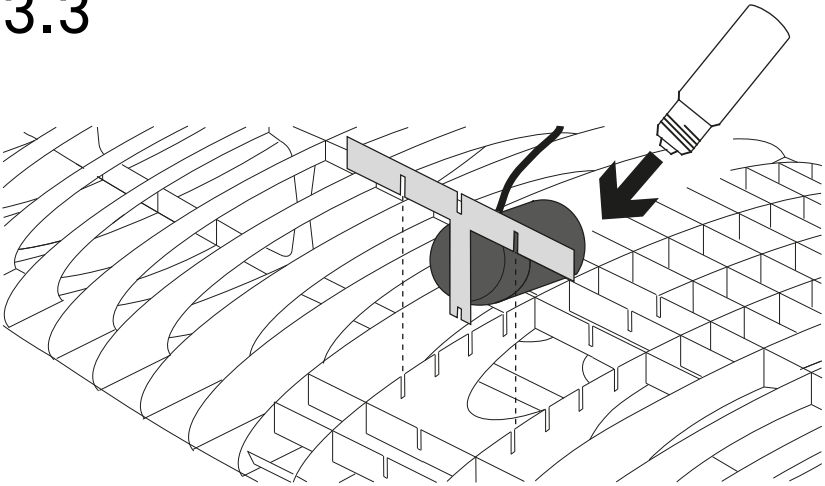

# 3.4

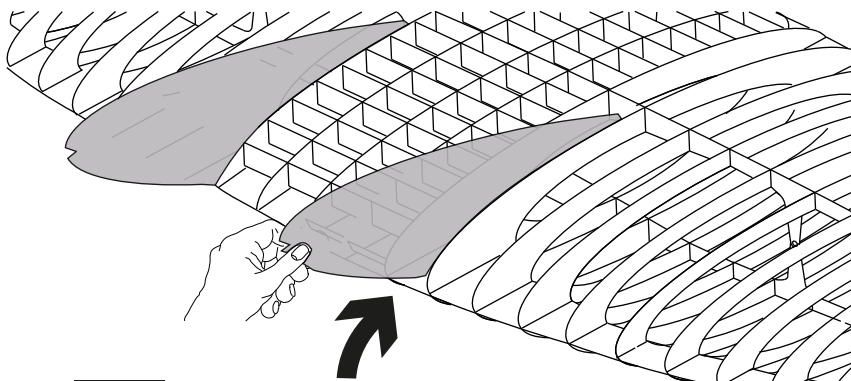
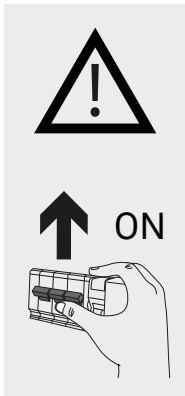
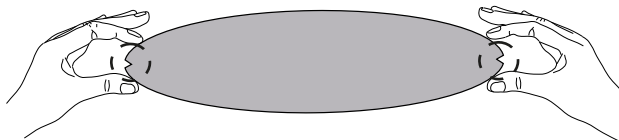

**LUCE  
PLAN**



# TITANIA

design Alberto Meda / Paolo Rizzato







**LUCE  
PLAN**

[www.luceplan.com](http://www.luceplan.com)

D170I0104

