

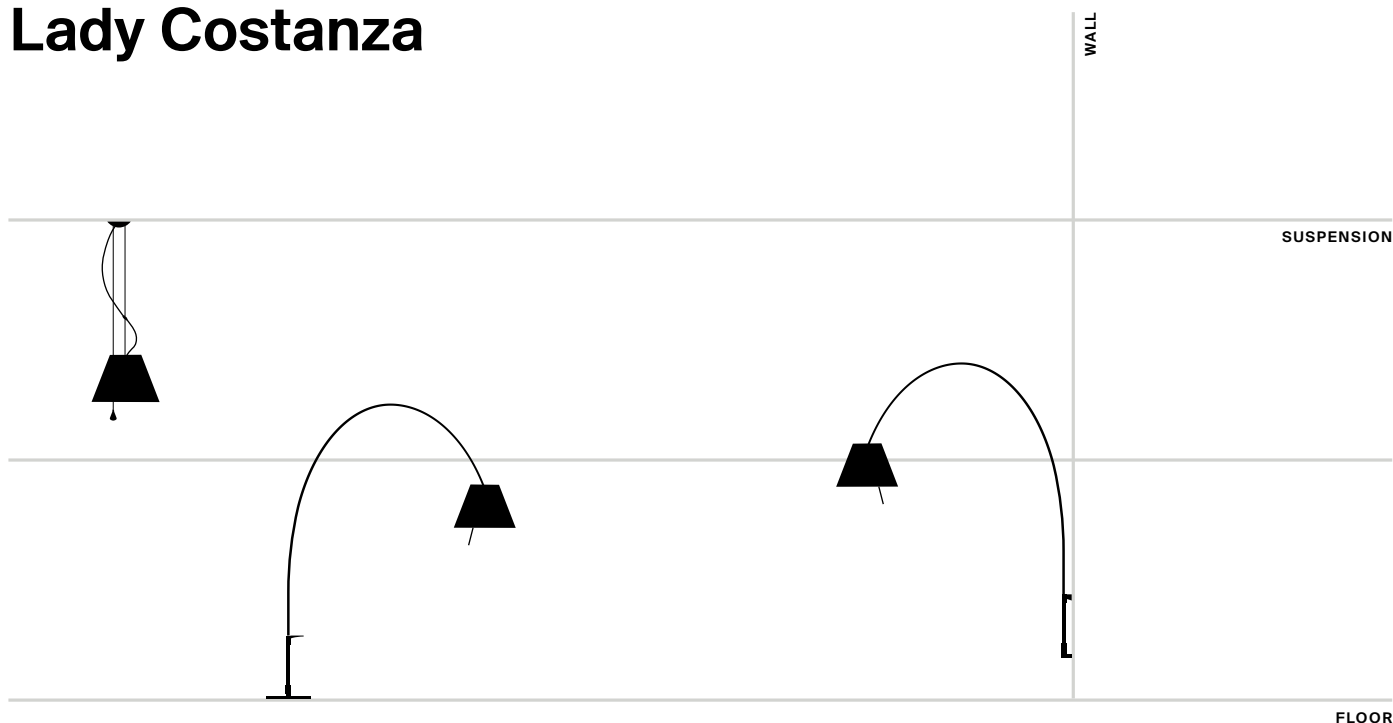



# Lady Costanza



Paolo Rizzatto, 2008

**EN** The telescopic stem and 360° rotation on the base give Lady Costanza elegant poise and flexibility, allowing the user to easily adjust the height and direction of the light. The extraordinarily limited weight of the structure and the handle on the base facilitate movement.

**IT** La regolazione telescopica dello stelo e la possibilità di rotazione a 360° sulla base, donano a Lady Costanza una elegante flessibilità, consentendo di variare a piacere l'altezza e l'orientamento nello spazio del suo diffusore. La straordinaria leggerezza della struttura e la maniglia di cui è dotata la base agevolano, inoltre, lo spostamento dell'apparecchio da un ambiente all'altro.

**DE** Der regulierbare Teleskopständer und die Möglichkeit einer Drehung von 360° an der Basis verleihen Lady Costanza elegante Flexibilität und bieten die Möglichkeit, Höhe und räumliche Ausrichtung des Schirms ganz nach Belieben zu ändern. Die außergewöhnliche Leichtigkeit der Struktur und der Griff an der Basis erleichtern außerdem das Versetzen der Leuchte von einem Raum in den anderen.

**FR** Le réglage télescopique du pied et la possibilité d'effectuer une rotation à 360° sur la base confèrent à Lady Costanza une souplesse élégante qui permet de varier en toute liberté la hauteur et l'orientation dans l'espace de son diffuseur. De plus, l'extraordinaire légèreté de la structure et la poignée située sur la base facilitent le déplacement de l'appareil d'un espace à l'autre.

**ES** La regulación telescópica del pie y la posibilidad de rotación a 360° en la base, confieren a Lady Costanza una elegante flexibilidad, permitiendo regular, según los gustos, la altura y la orientación en el espacio de su difusor. La extraordinaria ligereza de la estructura y la manilla de la que está dotada la base facilitan, además, el desplazamiento del aparato.





MOD. Lady Costanza

TECHNICAL DATA

D13E d  
sensor dimmer

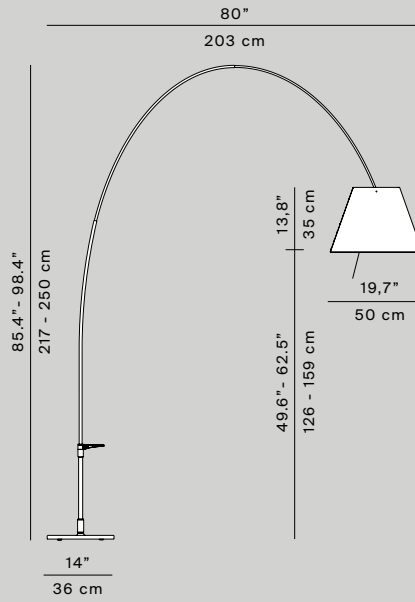

MOD. Lady Costanza

D13Ea d\*  
sensor dimmer

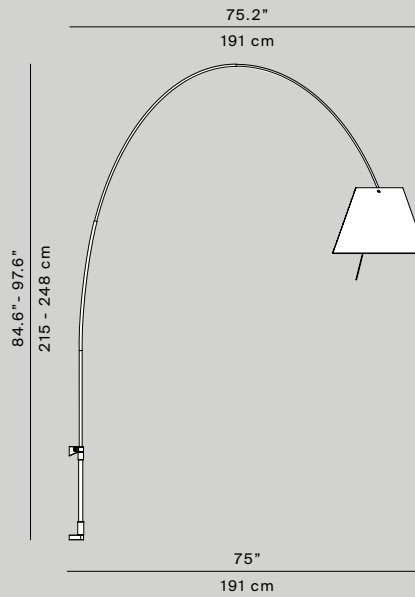

D13E sas  
dimmmable with  
wall control



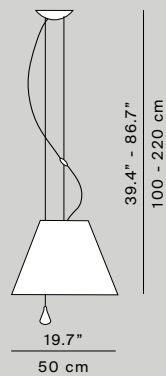



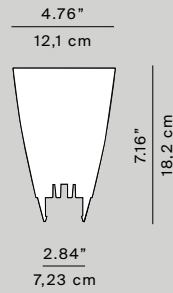

ceiling rose Ø 12 x 3 cm



**D13/91**  
diffuser accessory  
bulb not included



Polycarbonate diffuser for halogen  
E27 Energy saver max 105W bulbs.  
Mounting on the diffuser's rods  
support.

|                            |  |  |
|----------------------------|--|--|
| <b>Light source</b>        | <b>D13Ed / D13Ead / D13Esas</b>  | LED E27 dimmable (max weight 90g)<br>max 105W E27 energy saver |
| <b>Materials</b>           | Aluminium stem, polycarbonate shade  |  |
| <b>Structure finishes*</b> |  Alu  Black  |  |
| <b>Shade finishes</b>      |  Red  Black  White  Shaded stone |  |
|                            |      |  |

TECHNICAL DATA

MOD. Lady Costanza

MOD.

\* Wall version in alu finish only

[Luceplan.com](https://Luceplan.com)