

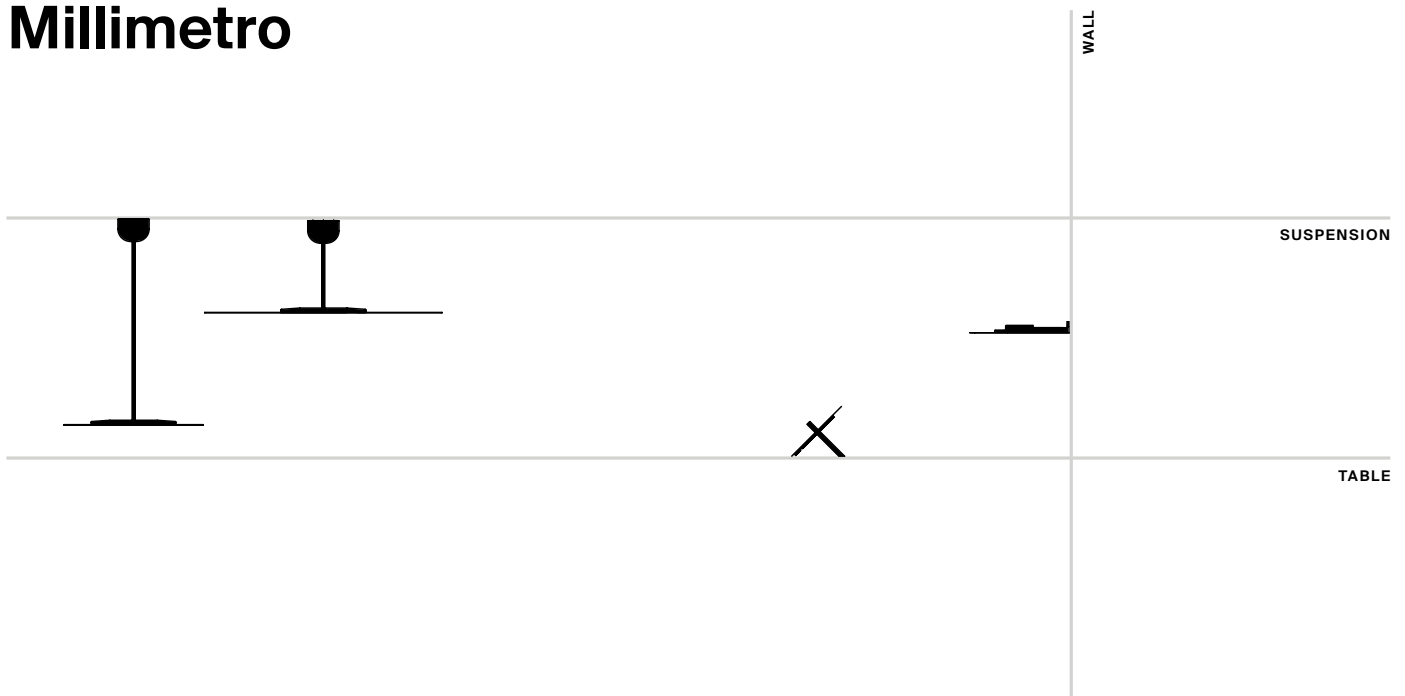



# Millimetro



Daniel Rybakken, 2022

**EN** Halfway between a suspension lamp and a ceiling lamp, Millimetro brings together a very thin circular mirror-finish disk, a support structure and enveloping, warm light that spreads on the ceiling. Millimetro is at its best in elegant, prestigious contexts, thanks to its refined reflecting surface, triggering a different perspective on the surrounding space. The wall version, tangential to the surface, seems to float in space, becoming part of the wall itself. Reprising the finishes of the suspension version, it can come with an optional accessory: a thin wall plate with a circular form.

**IT** A metà strada tra una lampada a sospensione e una a soffitto, Millimetro è caratterizzata da un sottilissimo disco circolare a specchio, una struttura portante e da una luce avvolgente e calda che si irradia sul soffitto. Millimetro trova la sua massima espressione in contesti eleganti e prestigiosi e, grazie alla sua raffinata superficie riflettente, offre una prospettiva differente sullo spazio circostante. La versione a parete, installata tangente al muro, sembra fluttuare nello spazio, diventando parte della parete stessa. Richiamando le finiture della versione sospensione, può presentare un accessorio opzionale: una sottile piastra a parete dalla forma circolare.

**DE** Zwischen einer Pendelleuchte und einer Deckenleuchte angesiedelt, zeichnet sich Millimetro durch eine äußerst dünne, kreisförmige Spiegelscheibe, eine tragende Struktur und ein warmes, umhüllendes Licht aus, das an die Decke strahlt. Millimetro kommt am besten in eleganten und prestigeträchtigen Umgebungen zur Geltung. Dank der raffinierten reflektierenden Oberfläche entsteht eine besondere Perspektive auf den umgebenden Raum. Die parallel installierte Wandversion scheint im Raum zu schweben und Teil der Wand selbst zu werden. Sie erinnert in ihrer Gestaltung an die Hängeversion und kann mit optionalem Zubehör ausgestattet werden: einer schmalen, runden Wandplatte.

**FR** À mi-chemin entre une lampe suspendue et un plafonnier, Millimetro se caractérise par un disque circulaire très fin en miroir, une structure de support et une lumière enveloppante et chaleureuse qui rayonne sur le plafond. Millimetro trouve sa meilleure expression dans des cadres élégants et prestigieux et, grâce à sa surface réfléchissante raffinée, offre une perspective différente sur l'espace environnant. La version murale, installée tangentiellement au mur, semble flotter dans l'espace, devenant une partie du mur lui-même. Rappelant les finitions de la version suspendue, elle peut présenter un accessoire optionnel : une plaque murale mince et circulaire.

**ES** A medio camino entre una lámpara colgante y una lámpara de techo, Millimetro se caracteriza por un disco circular de espejo muy fino, una estructura de soporte y una luz envolvente y cálida que irradia hacia el techo. Millimetro encuentra su mejor expresión en ambientes elegantes y prestigiosos y, gracias a su refinada superficie reflectante, ofrece una perspectiva diferente del espacio circundante. La versión de pared, instalada de manera tangente, parece flotar en el espacio, convirtiéndose en parte de la propia pared. Recordando los acabados de la versión suspendida, puede incorporar un accesorio opcional: una fina placa de pared circular.





MOD. Millimetro





MOD. Millimetro

TECHNICAL DATA

**A11S50W+A11/1T-A11/1D**  
**+ A11/2-A11/3-A11/4-A11/5**  
 dimmable phase cut or push/DALI  
 weight 3,5 Kg

**A11S85W+A11/1T-A11/1D**  
**+A11/2-A11/3-A11/4-A11/5**  
 dimmable phase cut or push/DALI  
 weight 6,3 Kg

**A11S50W**  
**+A11/1T-A11/1D**  
**+A11/2**

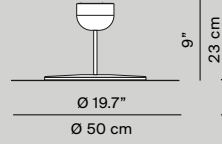

**A11S85W**  
**+A11/1T-A11/1D**  
**+A11/2**

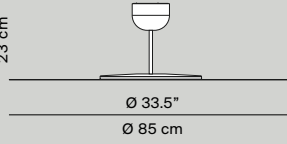

**A11S50W**  
**+A11/1T-A11/1D**  
**+A11/3**

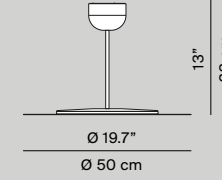

**A11S85W**  
**+A11/1T-A11/1D**  
**+A11/3**

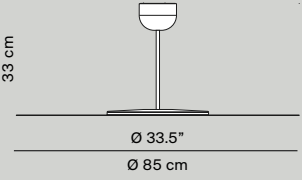

**A11S50W**  
**+A11/1T-A11/1D**  
**+A11/4**

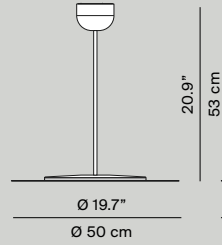

**A11S85W**  
**+A11/1T-A11/1D**  
**+A11/4**

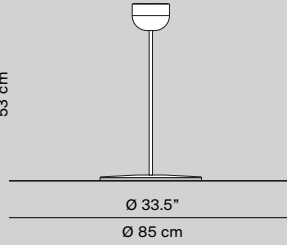

**A11S50W**  
**+A11/1T-A11/1D**  
**+A11/5**

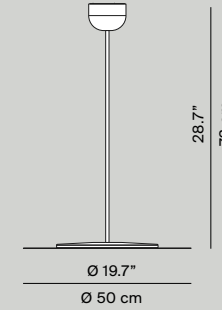

**A11S85W**  
**+A11/1T-A11/1D**  
**+A11/5**

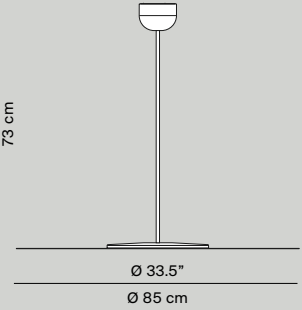

Millimetro

MOD.

**A11=1W**  
 dimmer on board  
 weight 0,52 Kg

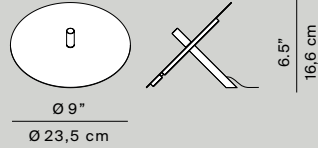



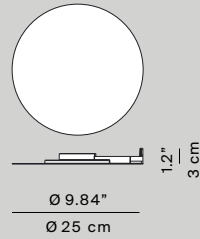

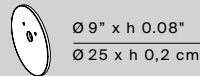

**A11A25W/A11A25**  
 weight 0,3 Kg



**Accessory A11/6**  
 for A11A25 / A11A25W ONLY  
 weight 0,1 Kg





<b>Light source</b>	<b>A11S50W / A11S85W+A11/2-A11/3-A11/4-A11/5+A11/1D</b>	LED 39W	2700K	CRI 90
	<b>A11S50W / A11S85W+A11/2-A11/3-A11/4-A11/5+A11/1T</b>	LED 37W	2700K	CRI 90
	<b>A11A25W / A11A25</b>	LED 22W	2700K/3000K	CRI 90
	<b>A11=1W</b>	LED 13W	2700 K	CRI 90
<b>Materials</b>	Aluminium disc, steel and brass structure, technopolymer diffuser			
<b>Structure finishes</b> ceiling / table	 Brass mirror	 Royal blue mirror	 Aluminium mirror	
<b>Structure finishes</b> wall	 Aluminium mirror			
<b>Structure finishes</b> Accessory back plate	 Brass	 Royal blue	 Aluminium	



[Luceplan.com](https://Luceplan.com)